

SK BRI4-1-100-100

Part number: 275 272 005

Internal braking resistor for connection to a
NORDAC FLEX SK 2xxE

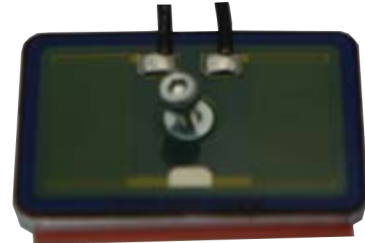

Only qualified electricians are allowed to install and commission the module. An electrician is a person who, because of their technical training and experience, has sufficient knowledge with regard to

- switching on, switching off, isolating, earthing and marking power circuits and devices,
- proper maintenance and use of protective devices in accordance with defined safety standards.

DANGER!

Danger of electric shock

The frequency inverter continues to carry hazardous voltages for up to 5 minutes after it was switched off.

- Work must not be carried out unless the device has been disconnected from the voltage and at least 5 minutes have elapsed since the mains was switched off!

CAUTION

Danger of burns

The module and all other metal components can heat up to temperatures above 70 °C.

Sufficient cooling time must be allowed for when working on the components in order to avoid injuries (local burns) to parts of the body coming into contact with the components.

In order to avoid damage to neighbouring objects, sufficient clearance must be maintained during installation.

NOTICE

Validity of this document

This document is only valid in combination with the operating instructions for the relevant frequency inverter. Safe commissioning of this module and the frequency inverter depends on the availability of this information.

Technical Information / Datasheet	SK BRI4-1-100-100			
Brake resistor	TI 2752272005	1.0	3018	en

Scope of delivery

Module		
1 x	Braking resistor	SK BRI4-1
1 x	Fastening screw	M4 x 12 hexagon socket screw
1 x	Washer	A 4.3
1 x	Adapter plate	Aluminium, 4 mm
1 x	Heat conducting film	Thermo-silicone, 0.3 mm



Field of use

Dynamic braking (frequency lowering) of a three-phase motor via a frequency inverter results in generator braking energy that – depending on the particular application – is dissipated by a braking resistor. This superfluous energy is transformed into heat.

The internal braking resistor is designed for the NORDAC *FLEX* SK 200E series of units and depends on the mains voltage and the power. The internal braking resistor can be used for applications in which only slight, short braking phases are to be expected.

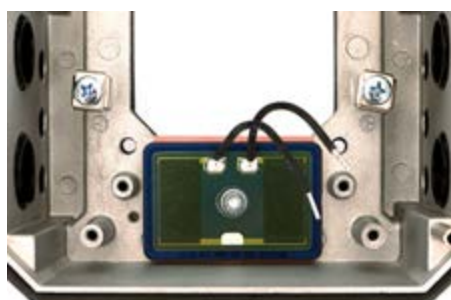

Technical Data

Electrical data

Number of leads		2
Resistance	Ω	100

Max. continuous power P _n 1)	W	100
Energy consumption P _{max} 2)	kWs	1.0

¹⁾ Reduction of the continuous power of the braking resistor to 25 % of the rated power.

²⁾ The stated value applies to a single use within 10 s.

General

Temperature range	°C	- 40 ... + 200
Tightening torque		
Screw	Nm	2.5 – 3.0
Weight	kg	0.08

Certifications	CE, RoHS, UL
Protection class	IP00
Mounting ¹⁾	
Hexagon socket screw	M4 x 12

¹⁾ The screw and the washer are included in the scope of delivery

Dimensions

Housing dimensions		
Total [mm]	W x H x D	61.0 x 44.0 x 5.8
Adapter plate [mm]	W x H x D	60.0 x 40.0 x 4.5
Heat conducting film [mm]	W x H x D	55.0 x 44.0 x 0.3
Resistance [mm]	W x H x D	61.0 x 41.0 x 1.0
Cable / line [mm]		
Lead black / black	L	60.0 / 60.0
Wire end sleeve	L	8.0

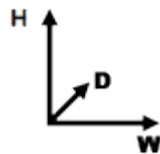

Connections

Name	+B	-B
Cross section / type	AWG 20	
Wire colour	Black	Black
Terminal label	Power terminal +B	Power terminal -B
Tightening torque SK 2xxE	1.2 – 1.5 Nm	

i Information

Versions

Due to the production process, various versions of braking resistor are available for installation and connection to *NORDAC FLEX* frequency inverters.



Older version

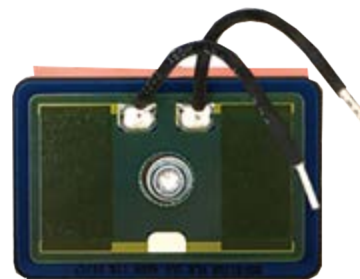

Current version

Frequency inverter assignment

i Information **Overview in the manual**

The braking resistors provided by the NORD DRIVESYSTEMS Group are specially designed for the particular frequency inverters.

Otherwise, the internal braking resistor and the frequency inverter may be damaged during operation.

For detailed information, please refer to section  Assignment of Braking Resistors, in the relevant frequency inverter manual  "Further documentation and software: www.nord.com".

Installation

Installation location	Direct installation and connection to a decentralised <i>NORDAC FLEX</i> frequency inverter: <ul style="list-style-type: none"> In the connection unit of the frequency inverter
Installation orientation	Option slot 2
Fastening	With screws (fastening material is included)



i Information **Assembly sequence**

To install or remove the internal braking resistor, a power terminal strip which must be removed from the connection unit.

For the use of Type SK CU4-... customer interfaces and depending on the type of device and the options used, further components may need to be removed.







With the motor mounted version, the motor cover / insulating plate must be correctly removed. In contrast, for a wall mounted version, no motor cover / insulating plate is installed in the connection unit.

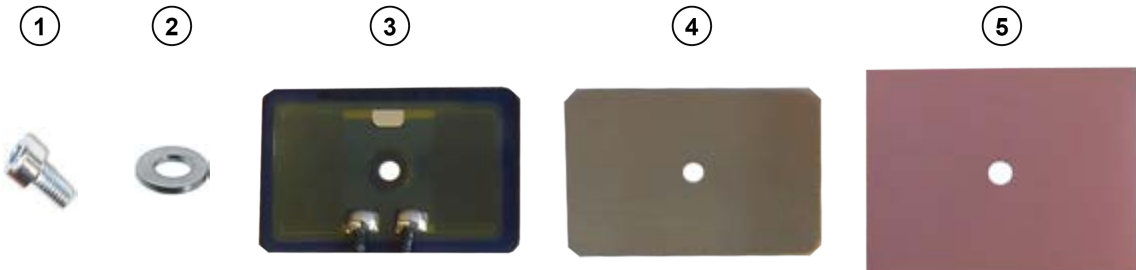
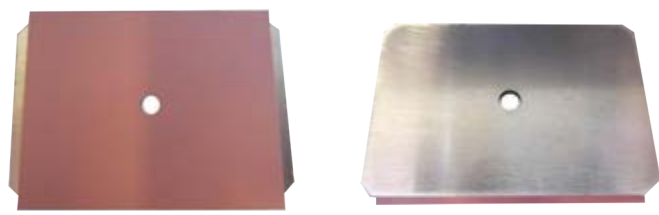

For detailed information regarding installation of the connection unit and the optional modules, please refer to section  Assembly and Installation, in the frequency inverter manual  "Further documentation and software: www.nord.com".

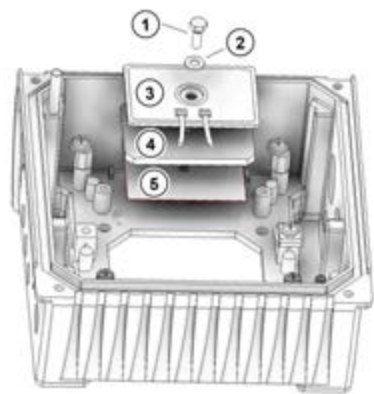
Installation steps

1.	<p>Installing the frequency inverter</p> <p>The SK 2xxE frequency inverter has not yet been installed on the SK T14 connection unit and the drive.</p>	 <p>Motor mounted version</p>
2.	<p>Installing the internal braking resistor</p> <p>The braking resistor is fastened to option slot 2 in the SK T14 connection unit.</p> <ul style="list-style-type: none"> All components are installed in the connection unit using the enclosed M4 hexagon socket screw and the washer. 	

3.	 <p> ① Screw ② Washer ③ Resistor ④ Adapter plate ⑤ Heat conducting film </p>	
	<p>Attach the heat conducting film to the adapter plate with the self-adhesive film.</p> <ul style="list-style-type: none"> • Caution: For this, the protective film must be removed from the heat conducting film. • Then place the adapter plate with the heat conducting film facing downwards into option slot 2 • Place the braking resistor on the adapter plate in the connection unit with the connecting wires facing inwards • Insert the hexagon socket screw with the washer into the fastening hole of the braking resistor • Firmly screw the braking resistor and adapter plate / heat conducting film to the connection unit  <p>The specified tightening torques (see  Technical Data – General) must be complied with for fastening.</p>	 
4.	<p>Connect the two connection wires to the power terminal strip or to the terminals of the frequency inverter.</p> <p>Black lead ⇔ -B Black lead ⇔ +B</p> <p>The specified tightening torques must be complied with; please refer to  Technical Data – Connections.</p>	

Information

Peak load limitation - DIP switch (S1)

If a type SK BRI4-...internal braking resistor is used, the DIP switch (S1) DIP No., 8 see  "Further documentation and software: www.nord.com", must be set to "On". This is important in order to activate a peak power limitation to protect the braking resistor.

Parameters



For optimum operation of the internal braking resistor, no parameters of the frequency inverter need to be changed. Limitation of the peak load is carried out solely via the hardware using DIP switch S1 with DIP No. 8 set to the position "On". Refer to the frequency inverter manual for details  "Further documentation and software: www.nord.com".

Error messages

Error messages of the internal braking resistor – the current or the archived message of the last fault – can be retrieved using the information parameters Actual fault P700 and Last fault P701 from the error memory of the frequency inverter. Refer to the frequency inverter manual for details  "Further documentation and software: www.nord.com").

Error (E030/E050)	Meaning	Remarks
3.1	I^2t overcurrent limit	Brake chopper: I^2t limit has been triggered, 1.5x value for 60 s reached <ul style="list-style-type: none"> Avoid overcurrent in brake resistance
5.0	Overvoltage UZW	Link circuit voltage too high <ul style="list-style-type: none"> Check the function of the connected braking resistor (broken cable) Resistance value of connected braking resistor too high

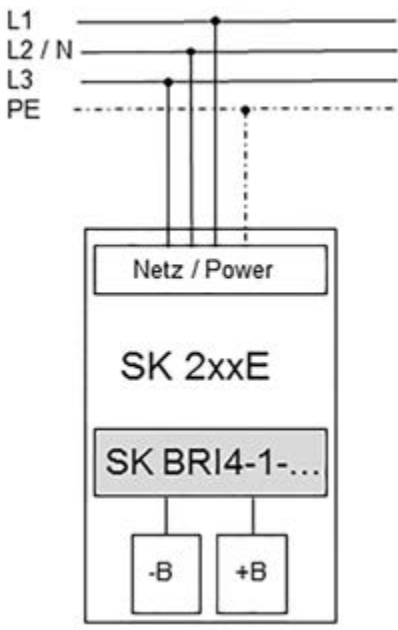
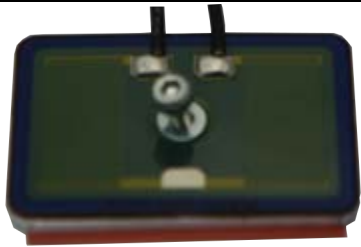
Wiring diagram

	 <p style="text-align: center;">Internal brake resistor SK BRI4-1-x00-x00</p>
 <p style="text-align: center;">Size 1 and Size 2 SK 2xxE</p>	 <p style="text-align: center;">Connection unit SK TI4-1 / SK TI4-2</p>

Further documentation and software: www.nord.com

Document	Designation
BU 0200	SK 200E frequency inverter manual

GETRIEBEBAU NORD

Member of the NORD DRIVESYSTEMS Group

Getriebebau NORD GmbH & Co. KG

Getriebebau-Nord-Straße 1 • 22941 Bargteheide, Germany • www.nord.com



SK BRI4-1-200-100

Part number: 275 272 008

Internal braking resistor for connection to a
NORDAC FLEX SK 2xxE

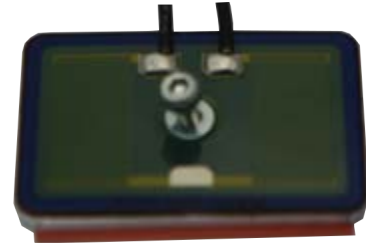

Only qualified electricians are allowed to install and commission the module. An electrician is a person who, because of their technical training and experience, has sufficient knowledge with regard to

- switching on, switching off, isolating, earthing and marking power circuits and devices,
- proper maintenance and use of protective devices in accordance with defined safety standards.

DANGER!

Danger of electric shock

The frequency inverter continues to carry hazardous voltages for up to 5 minutes after it was switched off.

- Work must not be carried out unless the device has been disconnected from the voltage and at least 5 minutes have elapsed since the mains was switched off!

CAUTION

Danger of burns

The module and all other metal components can heat up to temperatures above 70 °C.

Sufficient cooling time must be allowed for when working on the components in order to avoid injuries (local burns) to parts of the body coming into contact with the components.

In order to avoid damage to neighbouring objects, sufficient clearance must be maintained during installation.

NOTICE

Validity of this document

This document is only valid in combination with the operating instructions for the relevant frequency inverter. Safe commissioning of this module and the frequency inverter depends on the availability of this information.

Technical Information / Datasheet	SK BRI4-1-200-100			
Brake resistor	TI 2752272008	1.0	3018	en

Scope of delivery

Module		
1 x	Braking resistor	SK BRI4-1
1 x	Fastening screw	M4 x 12 hexagon socket screw
1 x	Washer	A 4.3
1 x	Adapter plate	Aluminium, 4 mm
1 x	Heat conducting film	Thermo-silicone, 0.3 mm



Field of use

Dynamic braking (frequency lowering) of a three-phase motor via a frequency inverter results in generator braking energy that – depending on the particular application – is dissipated by a braking resistor. This superfluous energy is transformed into heat.

The internal braking resistor is designed for the NORDAC *FLEX* SK 200E series of units and depends on the mains voltage and the power. The internal braking resistor can be used for applications in which only slight, short braking phases are to be expected.

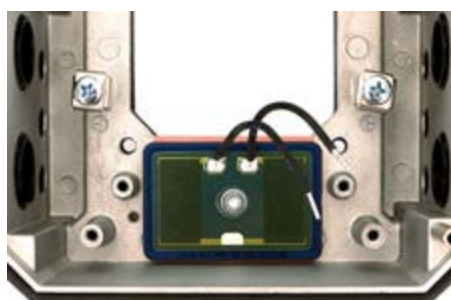

Technical Data

Electrical data

Number of leads		2
Resistance	Ω	200

Max. continuous power P _n 1)	W	100
Energy consumption P _{max} 2)	kWs	1.0

¹⁾ Reduction of the continuous power of the braking resistor to 25 % of the rated power.

²⁾ The stated value applies to a single use within 10 s.

General

Temperature range	°C	- 40 ... + 200
Tightening torque		
Screw	Nm	2.5 – 3.0
Weight	kg	0.08

Certifications	CE, RoHS, UL
Protection class	IP00
Mounting ¹⁾	
Hexagon socket screw	M4 x 12

¹⁾ The screw and the washer are included in the scope of delivery

Dimensions

Housing dimensions		
Total [mm]	W x H x D	61.0 x 44.0 x 5.8
Adapter plate [mm]	W x H x D	60.0 x 40.0 x 4.5
Heat conducting film [mm]	W x H x D	55.0 x 44.0 x 0.3
Resistance [mm]	W x H x D	61.0 x 41.0 x 1.0
Cable / line [mm]		
Lead black / black	L	60.0 / 60.0
Wire end sleeve	L	8.0

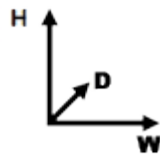

Connections

Name	+B	-B
Cross section / type	AWG 20	
Wire colour	Black	Black
Terminal label	Power terminal +B	Power terminal -B
Tightening torque SK 2xxE	1.2 – 1.5 Nm	

i Information

Versions

Due to the production process, various versions of braking resistor are available for installation and connection to *NORDAC FLEX* frequency inverters.



Older version

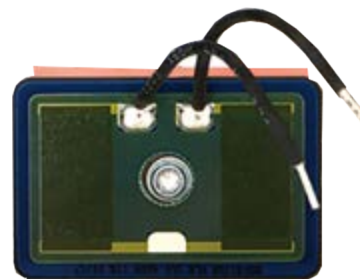



Current version

Frequency inverter assignment

i Information **Overview in the manual**

The braking resistors provided by the NORD DRIVESYSTEMS Group are specially designed for the particular frequency inverters.

Otherwise, the internal braking resistor and the frequency inverter may be damaged during operation.

For detailed information, please refer to section  Assignment of Braking Resistors, in the relevant frequency inverter manual  "Further documentation and software: www.nord.com".

Installation

Installation location	Direct installation and connection to a decentralised <i>NORDAC FLEX</i> frequency inverter: <ul style="list-style-type: none"> • In the connection unit of the frequency inverter
Installation orientation	Option slot 2
Fastening	With screws (fastening material is included)



i Information **Assembly sequence**

To install or remove the internal braking resistor, a power terminal strip which must be removed from the connection unit.

For the use of Type SK CU4-... customer interfaces and depending on the type of device and the options used, further components may need to be removed.







With the motor mounted version, the motor cover / insulating plate must be correctly removed. In contrast, for a wall mounted version, no motor cover / insulating plate is installed in the connection unit.

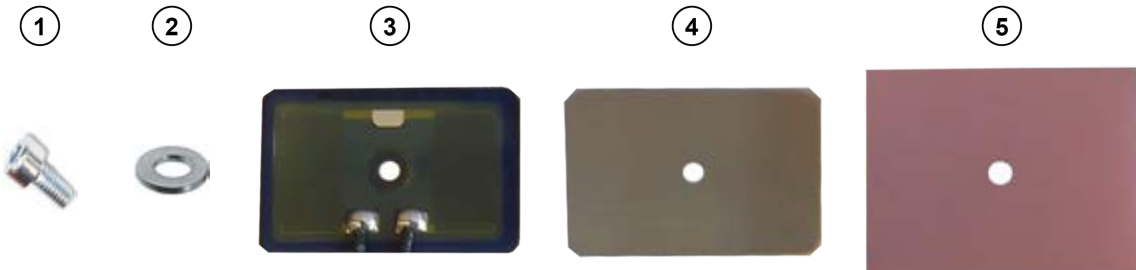
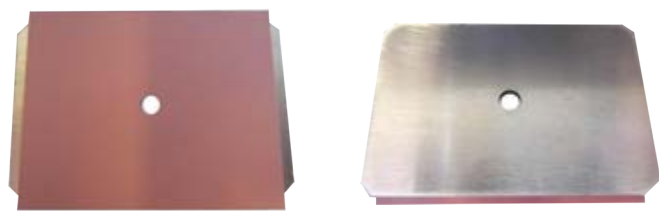

For detailed information regarding installation of the connection unit and the optional modules, please refer to section  Assembly and Installation, in the frequency inverter manual  "Further documentation and software: www.nord.com".

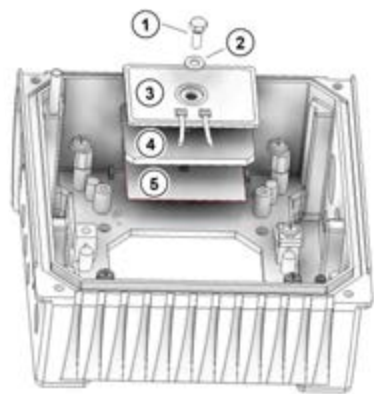
Installation steps

1.	Installing the frequency inverter The SK 2xxE frequency inverter has not yet been installed on the SK T14 connection unit and the drive.	 Motor mounted version
2.	Installing the internal braking resistor The braking resistor is fastened to option slot 2 in the SK T14 connection unit. <ul style="list-style-type: none"> • All components are installed in the connection unit using the enclosed M4 hexagon socket screw and the washer. 	

3.	 <p> ① Screw ② Washer ③ Resistor ④ Adapter plate ⑤ Heat conducting film </p>	
	<p>Attach the heat conducting film to the adapter plate with the self-adhesive film.</p> <ul style="list-style-type: none"> • Caution: For this, the protective film must be removed from the heat conducting film. • Then place the adapter plate with the heat conducting film facing downwards into option slot 2 • Place the braking resistor on the adapter plate in the connection unit with the connecting wires facing inwards • Insert the hexagon socket screw with the washer into the fastening hole of the braking resistor • Firmly screw the braking resistor and adapter plate / heat conducting film to the connection unit  <p>The specified tightening torques (see  Technical Data – General) must be complied with for fastening.</p>	 
4.	<p>Connect the two connection wires to the power terminal strip or to the terminals of the frequency inverter.</p> <p>Black lead ⇔ -B Black lead ⇔ +B</p> <p>The specified tightening torques must be complied with; please refer to  Technical Data – Connections.</p>	

Information

Peak load limitation - DIP switch (S1)

If a type SK BRI4-...internal braking resistor is used, the DIP switch (S1) DIP No., 8 see  "Further documentation and software: www.nord.com", must be set to "On". This is important in order to activate a peak power limitation to protect the braking resistor.

Parameters



For optimum operation of the internal braking resistor, no parameters of the frequency inverter need to be changed. Limitation of the peak load is carried out solely via the hardware using DIP switch S1 with DIP No. 8 set to the position "On". Refer to the frequency inverter manual for details  "Further documentation and software: www.nord.com".

Error messages

Error messages of the internal braking resistor – the current or the archived message of the last fault – can be retrieved using the information parameters Actual fault P700 and Last fault P701 from the error memory of the frequency inverter. Refer to the frequency inverter manual for details  "Further documentation and software: www.nord.com").

Error (E030/E050)	Meaning	Remarks
3.1	I^2t overcurrent limit	Brake chopper: I^2t limit has been triggered, 1.5x value for 60 s reached <ul style="list-style-type: none"> Avoid overcurrent in brake resistance
5.0	Overvoltage UZW	Link circuit voltage too high <ul style="list-style-type: none"> Check the function of the connected braking resistor (broken cable) Resistance value of connected braking resistor too high

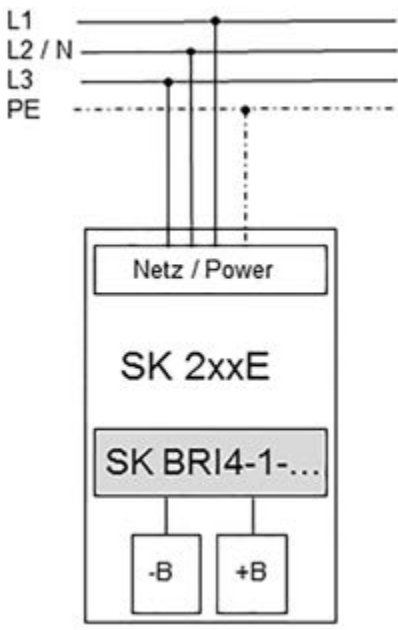
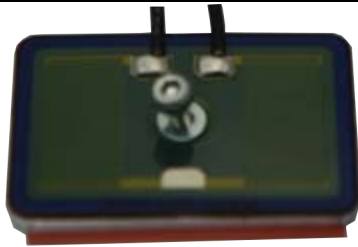
Wiring diagram

	 <p>Internal brake resistor SK BRI4-1-x00-x00</p>
 <p>Size 1 and Size 2 SK 2xxE</p>	 <p>Connection unit SK TI4-1 / SK TI4-2</p>

Further documentation and software: www.nord.com

Document	Designation
BU 0200	SK 200E frequency inverter manual

GETRIEBEBAU NORD

Member of the NORD DRIVESYSTEMS Group

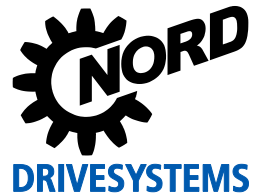

Getriebebau NORD GmbH & Co. KG

Getriebebau-Nord-Straße 1 • 22941 Bargteheide, Germany • www.nord.com

SK BRI4-1-400-100

Part number: 275 272 012

Internal braking resistor for connection to a
NORDAC FLEX SK 2xxE

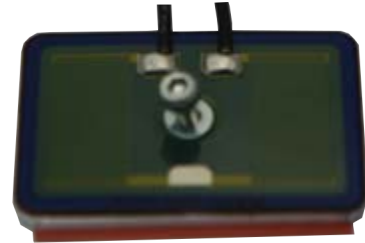

Only qualified electricians are allowed to install and commission the module. An electrician is a person who, because of their technical training and experience, has sufficient knowledge with regard to

- switching on, switching off, isolating, earthing and marking power circuits and devices,
- proper maintenance and use of protective devices in accordance with defined safety standards.

DANGER!

Danger of electric shock

The frequency inverter continues to carry hazardous voltages for up to 5 minutes after it was switched off.

- Work must not be carried out unless the device has been disconnected from the voltage and at least 5 minutes have elapsed since the mains was switched off!

CAUTION

Danger of burns

The module and all other metal components can heat up to temperatures above 70 °C.

Sufficient cooling time must be allowed for when working on the components in order to avoid injuries (local burns) to parts of the body coming into contact with the components.

In order to avoid damage to neighbouring objects, sufficient clearance must be maintained during installation.

NOTICE

Validity of this document

This document is only valid in combination with the operating instructions for the relevant frequency inverter. Safe commissioning of this module and the frequency inverter depends on the availability of this information.

Technical Information / Datasheet	SK BRI4-1-400-100			
Brake resistor	TI 2752272012	1.0	3018	en

Scope of delivery

Module		
1 x	Braking resistor	SK BRI4-1
1 x	Fastening screw	M4 x 12 hexagon socket screw
1 x	Washer	A 4.3
1 x	Adapter plate	Aluminium, 4 mm
1 x	Heat conducting film	Thermo-silicone, 0.3 mm



Field of use

Dynamic braking (frequency lowering) of a three-phase motor via a frequency inverter results in generator braking energy that – depending on the particular application – is dissipated by a braking resistor. This superfluous energy is transformed into heat.

The internal braking resistor is designed for the NORDAC FLEX SK 200E series of units and depends on the mains voltage and the power. The internal braking resistor can be used for applications in which only slight, short braking phases are to be expected.

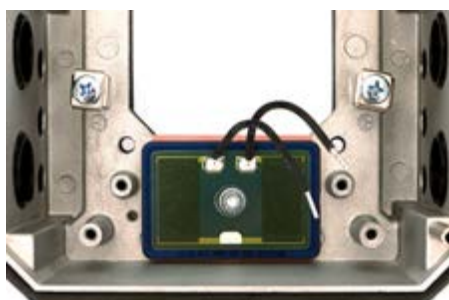

Technical Data

Electrical data

Number of leads		2
Resistance	Ω	400

Max. continuous power P_n 1)	W	100
Energy consumption P_{max} 2)	kWs	1.0

¹⁾ Reduction of the continuous power of the braking resistor to 25 % of the rated power.

²⁾ The stated value applies to a single use within 10 s.

General

Temperature range	$^{\circ}\text{C}$	- 40 ... + 200
Tightening torque		
Screw	Nm	2.5 – 3.0
Weight	kg	0.08

Certifications	CE, RoHS, UL	
Protection class	IP00	
Mounting ¹⁾		
Hexagon socket screw	M4 x 12	

¹⁾ The screw and the washer are included in the scope of delivery

Dimensions

Housing dimensions		
Total [mm]	W x H x D	61.0 x 44.0 x 5.8
Adapter plate [mm]	W x H x D	60.0 x 40.0 x 4.5
Heat conducting film [mm]	W x H x D	55.0 x 44.0 x 0.3
Resistance [mm]	W x H x D	61.0 x 41.0 x 1.0
Cable / line [mm]		
Lead black / black	L	60.0 / 60.0
Wire end sleeve	L	8.0

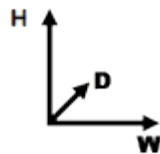

Connections

Name	+B	-B
Cross section / type	AWG 20	
Wire colour	Black	Black
Terminal label	Power terminal +B	Power terminal -B
Tightening torque SK 2xxE	1.2 – 1.5 Nm	

i Information

Versions

Due to the production process, various versions of braking resistor are available for installation and connection to *NORDAC FLEX* frequency inverters.



Older version

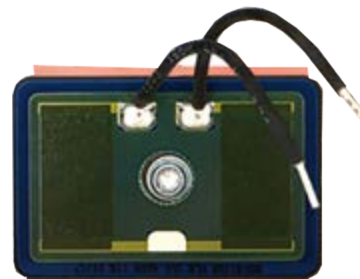

Current version



Frequency inverter assignment

i Information

Overview in the manual

The braking resistors provided by the NORD DRIVESYSTEMS Group are specially designed for the particular frequency inverters.

Otherwise, the internal braking resistor and the frequency inverter may be damaged during operation.

For detailed information, please refer to section  Assignment of Braking Resistors, in the relevant frequency inverter manual  "Further documentation and software: www.nord.com".

Installation

Installation location	Direct installation and connection to a decentralised <i>NORDAC FLEX</i> frequency inverter: <ul style="list-style-type: none"> In the connection unit of the frequency inverter
Installation orientation	Option slot 2
Fastening	With screws (fastening material is included)

i Information



Assembly sequence

To install or remove the internal braking resistor, a power terminal strip which must be removed from the connection unit.

For the use of Type SK CU4-... customer interfaces and depending on the type of device and the options used, further components may need to be removed.







With the motor mounted version, the motor cover / insulating plate must be correctly removed. In contrast, for a wall mounted version, no motor cover / insulating plate is installed in the connection unit.

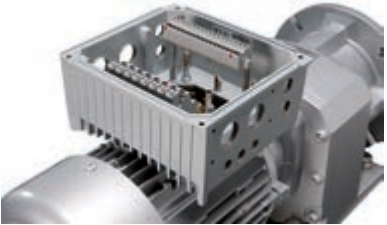

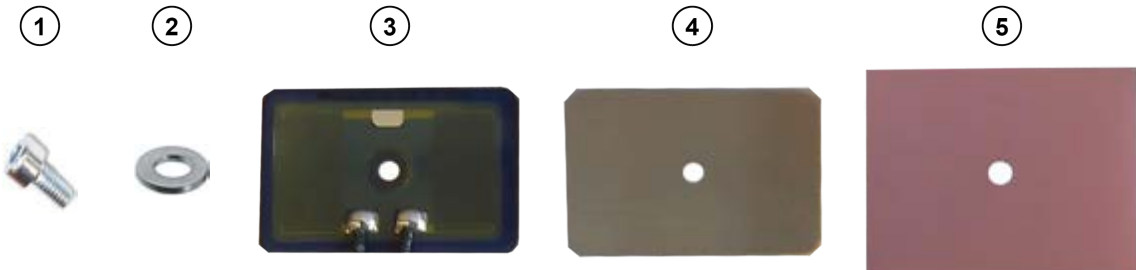
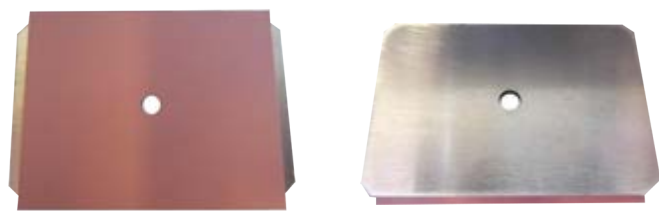
For detailed information regarding installation of the connection unit and the optional modules, please refer to section  Assembly and Installation, in the frequency inverter manual  "Further documentation and software: www.nord.com".

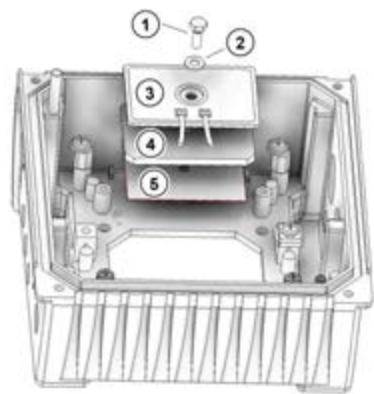
Installation steps

1.	Installing the frequency inverter The SK 2xxE frequency inverter has not yet been installed on the SK T14 connection unit and the drive.	 Motor mounted version
2.	Installing the internal braking resistor The braking resistor is fastened to option slot 2 in the SK T14 connection unit. <ul style="list-style-type: none"> All components are installed in the connection unit using the enclosed M4 hexagon socket screw and the washer. 	

3.	 <p>① Screw ② Washer ③ Resistor ④ Adapter plate ⑤ Heat conducting film</p>	
	<p>Attach the heat conducting film to the adapter plate with the self-adhesive film.</p> <ul style="list-style-type: none"> • Caution: For this, the protective film must be removed from the heat conducting film. • Then place the adapter plate with the heat conducting film facing downwards into option slot 2 • Place the braking resistor on the adapter plate in the connection unit with the connecting wires facing inwards • Insert the hexagon socket screw with the washer into the fastening hole of the braking resistor • Firmly screw the braking resistor and adapter plate / heat conducting film to the connection unit  <p>The specified tightening torques (see  Technical Data – General) must be complied with for fastening.</p>	 
4.	<p>Connect the two connection wires to the power terminal strip or to the terminals of the frequency inverter.</p> <p>Black lead ⇔ -B Black lead ⇔ +B</p> <p>The specified tightening torques must be complied with; please refer to  Technical Data – Connections.</p>	

Information

Peak load limitation - DIP switch (S1)

If a type SK BRI4-...internal braking resistor is used, the DIP switch (S1) DIP No., 8 see  "Further documentation and software: www.nord.com", must be set to "On". This is important in order to activate a peak power limitation to protect the braking resistor.

Parameters



For optimum operation of the internal braking resistor, no parameters of the frequency inverter need to be changed. Limitation of the peak load is carried out solely via the hardware using DIP switch S1 with DIP No. 8 set to the position "On". Refer to the frequency inverter manual for details  "Further documentation and software: www.nord.com".

Error messages

Error messages of the internal braking resistor – the current or the archived message of the last fault – can be retrieved using the information parameters Actual fault P700 and Last fault P701 from the error memory of the frequency inverter. Refer to the frequency inverter manual for details  "Further documentation and software: www.nord.com").

Error (E030/E050)	Meaning	Remarks
3.1	I ² t overcurrent limit	Brake chopper: I ² t limit has been triggered, 1.5x value for 60 s reached <ul style="list-style-type: none"> Avoid overcurrent in brake resistance
5.0	Overvoltage UZW	Link circuit voltage too high <ul style="list-style-type: none"> Check the function of the connected braking resistor (broken cable) Resistance value of connected braking resistor too high

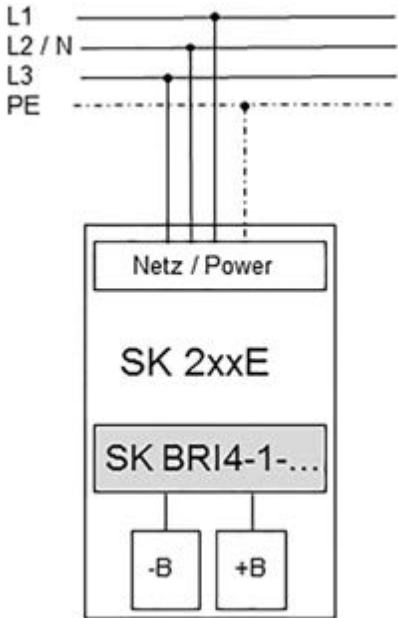
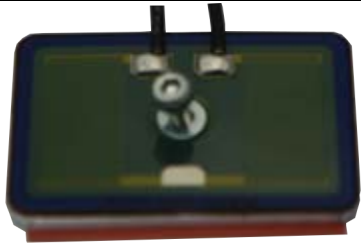
Wiring diagram

	 Internal brake resistor SK BRI4-1-x00-x00
 Size 1 and Size 2 SK 2xxE	 Connection unit SK TI4-1 / SK TI4-2

Further documentation and software: www.nord.com

Document	Designation
BU_0200	SK 200E frequency inverter manual

GETRIEBEBAU NORD

Member of the NORD DRIVESYSTEMS Group

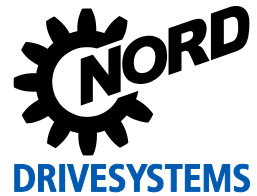

Getriebebau NORD GmbH & Co. KG

Getriebebau-Nord-Straße 1 • 22941 Bargteheide, Germany • www.nord.com

SK BRI4-2-100-200

Part number: 275 272 105

Internal braking resistor for connection to a
NORDAC FLEX SK 2xxE-FDS



Only qualified electricians are allowed to install and commission the module. An electrician is a person who, because of their technical training and experience, has sufficient knowledge with regard to

- switching on, switching off, isolating, earthing and marking power circuits and devices,
- proper maintenance and use of protective devices in accordance with defined safety standards.

DANGER!

Danger of electric shock

The frequency inverter continues to carry hazardous voltages for up to 5 minutes after it was switched off.

- Work must not be carried out unless the device has been disconnected from the voltage and at least 5 minutes have elapsed since the mains was switched off!

CAUTION

Danger of burns

The module and all other metal components can heat up to temperatures above 70 °C.

Sufficient cooling time must be allowed for when working on the components in order to avoid injuries (local burns) to parts of the body coming into contact with the components.

In order to avoid damage to neighbouring objects, sufficient clearance must be maintained during installation.

NOTICE

Validity of this document

This document is only valid in combination with the operating instructions for the relevant frequency inverter. Safe commissioning of this module and the frequency inverter depends on the availability of this information.

Technical Information / Datasheet	SK BRI4-2-100-200			
Brake resistor	TI 2752272105	1.0	3018	en

Scope of delivery

Module		
1 x	Braking resistor	SK BRI4-2
1 x	Fastening screw	M4 x 12 hexagon socket screw
1 x	Washer	A 4.3
1 x	Adapter plate	Aluminium, 5 mm
1 x	Heat conducting film	Thermo-silicone, 0.3 mm



Field of use

Dynamic braking (frequency lowering) of a three-phase motor using a frequency inverter results in generator braking energy that – depending on the particular application – is dissipated by a braking resistor. This superfluous energy is transformed into heat.

The internal braking resistor is designed for the NORDAC *FLEX* SK 200E series of units and depends on the mains voltage and the power. The internal brake resistor can be used for applications in which only slight, short braking phases are to be expected.



Technical Data

Electrical data

Number of leads		2
Resistance	Ω	100

Max. continuous power P_n 1)	W	200
Energy consumption P_{max} 2)	kWs	2.0

¹⁾ Reduction of the continuous power of the braking resistor to 25 % of the rated power.

²⁾ The stated value applies to a single use within 10 s.

General

Temperature range	°C	- 40 ... + 200
Tightening torque		
Screw	Nm	2.5 – 3.0
Weight	kg	0.09

Certifications	CE, RoHS, UL
Protection class	IP00
Mounting ¹⁾	
Hexagon socket screw	M4 x 12

¹⁾ The screw and the washer are included in the scope of delivery

Dimensions

Housing dimensions		
Total [mm]	W x H x D	69.5 x 55.0 x 6.8
Adapter plate [mm]	W x H x D	69.0 x 51.0 x 5.5
Heat conducting film [mm]	W x H x D	65.0 x 55.0 x 0.3
Resistance [mm]	W x H x D	69.5 x 51.5 x 1.0
Cable / line [mm]		
Lead blue / blue	L	60.0 / 60.0
Wire end sleeve	L	8.0

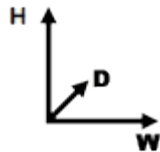

Connections

Name	+B	-B
Cross section / type	AWG 18	
Wire colour	Blue	Blue
Terminal label	Power terminal +B	Power terminal -B
Tightening torque SK 2xxE	1.2 – 1.5 Nm	

i Information

Versions

Due to the production process, various versions of braking resistor are available for installation and connection to *NORDAC FLEX* frequency inverters.



Older version

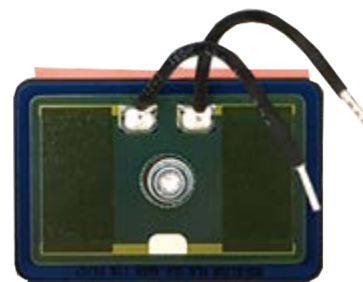

Current version

Frequency inverter assignment

i Information

Overview in the manual

The braking resistors provided by the NORD DRIVESYSTEMS Group are specially designed for the particular frequency inverters.

Otherwise, the internal braking resistor and the frequency inverter may be damaged during operation.

For detailed information, please refer to section  Assignment of Braking Resistors, in the relevant frequency inverter manual  "Further documentation and software: www.nord.com".

Installation

Installation location	Direct installation and connection to a decentralised <i>NORDAC FLEX</i> frequency inverter: <ul style="list-style-type: none"> • In the connection unit of the frequency inverter
Installation orientation	Option slot 2
Fastening	With screws (fastening material is included)

i Information



Assembly sequence

To install or remove the internal braking resistor, a power terminal strip which must be removed from the connection unit.

For the use of Type SK CU4-... customer interfaces and depending on the type of device and the options used, further components may need to be removed.









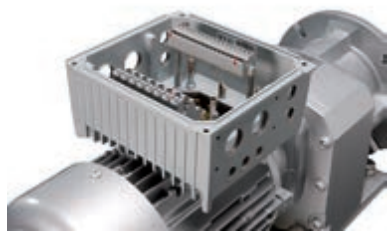

With the motor mounted version, the motor cover / insulating plate must be correctly removed. In contrast, for a wall mounted version, no motor cover / insulating plate is installed in the connection unit.

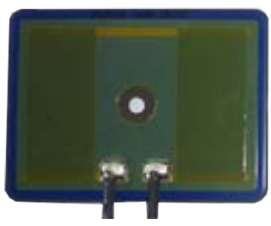

For detailed information regarding installation of the connection unit and the optional modules, please refer to section  Assembly and Installation, in the frequency inverter manual  "Further documentation and software: www.nord.com".

Installation steps

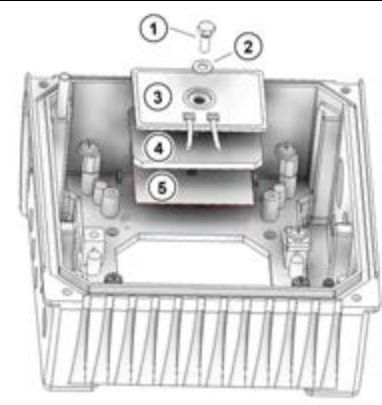
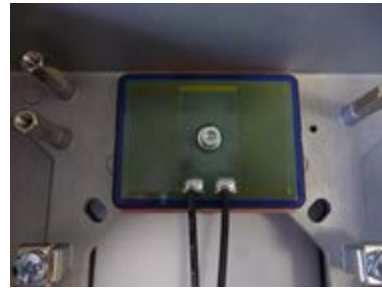
1.	<p>Installing the frequency inverter</p> <p>The SK 2xxE frequency inverter is not yet installed on the SK T14 connection unit and the drive.</p>	 <p>Motor mounted version</p>
2.	<p>Installing the internal braking resistor</p> <p>The braking resistor is fastened to option slot 2 in the SK T14 connection unit.</p> <ul style="list-style-type: none"> • All components are installed in the connection unit using the enclosed M4 hexagon socket screw and the washer. 	

3.	<div style="display: flex; justify-content: space-around; align-items: center;"> <div style="text-align: center;">  <p>① Screw</p> </div> <div style="text-align: center;">  <p>② Washer</p> </div> <div style="text-align: center;">  <p>③ Resistor</p> </div> <div style="text-align: center;">  <p>④ Adapter plate</p> </div> <div style="text-align: center;">  <p>⑤ Heat conducting film</p> </div> </div> <p>Attach the heat conducting film to the adapter plate with the self-adhesive film.</p> <ul style="list-style-type: none"> • Caution: For this, the protective film must be removed from the heat conducting film. • Then place the adapter plate with the heat conducting film facing downwards into option slot 2 • Place the braking resistor on the adapter plate in the connection unit with the connecting wires facing inwards • Insert the hexagon socket screw with the washer into the fastening hole of the braking resistor • Firmly screw the braking resistor and adapter plate / heat conducting film to the connection unit <div style="display: flex; justify-content: space-around; align-items: center;">   </div> <p>The specified tightening torques (see  Technical Data – General) must be complied with for fastening.</p>	 
4.	<p>Connect the two connection wires to the power terminal strip or to the terminals of the frequency inverter.</p> <p>Black lead ⇔ -B Black lead ⇔ +B</p> <p>Please heed the specified tightening torques; refer to  Technical Data – Connections.</p>	

Information

Peak load limitation - DIP switch (S1)

If a type SK BRI4-...internal braking resistor is used, the DIP switch (S1) DIP No., 8 see  "Further documentation and software: www.nord.com", must be set to "On". This is important in order to activate a peak power limitation to protect the braking resistor.

Parameters





For optimum operation of the internal braking resistor, no parameters of the frequency inverter need to be changed. Limitation of the peak load is carried out solely via the hardware using DIP switch S1 with DIP No. 8 set to the position "On". Refer to the frequency inverter manual for details  "Further documentation and software: www.nord.com".

Error messages

Error messages of the internal braking resistor – the current or the archived message of the last fault – can be retrieved using the information parameters Actual fault P700 and Last fault P701 from the error memory of the frequency inverter. Refer to the frequency inverter manual for details  "Further documentation and software: www.nord.com").

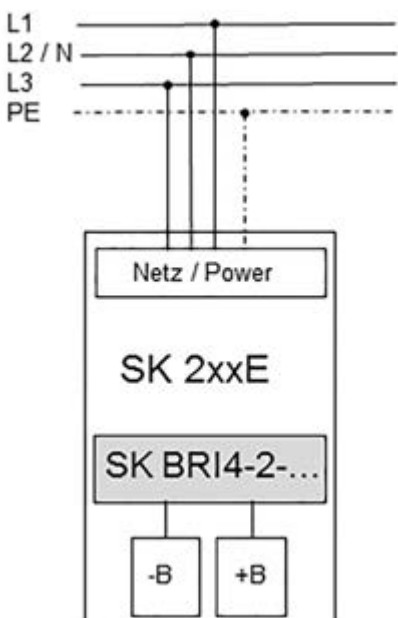
Error (E030/E050)	Meaning	Remarks
3.1	I ² t overcurrent limit	Brake chopper: I ² t limit has been triggered, 1.5x value for 60 s reached <ul style="list-style-type: none"> Avoid overcurrent in brake resistance
5.0	Overvoltage UZW	Link circuit voltage too high <ul style="list-style-type: none"> Check the function of the connected braking resistor (broken cable) Resistance value of connected braking resistor too high

Wiring diagram

	 <p>Internal brake resistor SK BRI4-2-x00-x00</p>
 <p>Size 3 SK 2xxE</p>	 <p>Connection unit SK TI4-3</p>

Further documentation and software: www.nord.com

Document	Designation
BU 0200	SK 200E frequency inverter manual

GETRIEBEBAU NORD

Member of the NORD DRIVESYSTEMS Group

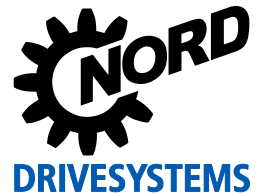

Getriebebau NORD GmbH & Co. KG

Getriebebau-Nord-Straße 1 • 22941 Bargteheide, Germany • www.nord.com

SK BRI4-2-200-200

Part number: 275 272 108

Internal braking resistor for connection to a
NORDAC FLEX SK 2xxE-FDS



Only qualified electricians are allowed to install and commission the module. An electrician is a person who, because of their technical training and experience, has sufficient knowledge with regard to

- switching on, switching off, isolating, earthing and marking power circuits and devices,
- proper maintenance and use of protective devices in accordance with defined safety standards.

DANGER!

Danger of electric shock

The frequency inverter continues to carry hazardous voltages for up to 5 minutes after it was switched off.

- Work must not be carried out unless the device has been disconnected from the voltage and at least 5 minutes have elapsed since the mains was switched off!

CAUTION

Danger of burns

The module and all other metal components can heat up to temperatures above 70 °C.

Sufficient cooling time must be allowed for when working on the components in order to avoid injuries (local burns) to parts of the body coming into contact with the components.

In order to avoid damage to neighbouring objects, sufficient clearance must be maintained during installation.

NOTICE

Validity of this document

This document is only valid in combination with the operating instructions for the relevant frequency inverter. Safe commissioning of this module and the frequency inverter depends on the availability of this information.

Technical Information / Datasheet	SK BRI4-2-200-200			
Brake resistor	TI 2752272108	1.0	3018	en

Scope of delivery

Module		
1 x	Braking resistor	SK BRI4-2
1 x	Fastening screw	M4 x 12 hexagon socket screw
1 x	Washer	A 4.3
1 x	Adapter plate	Aluminium, 5 mm
1 x	Heat conducting film	Thermo-silicone, 0.3 mm



Field of use

Dynamic braking (frequency lowering) of a three-phase motor using a frequency inverter results in generator braking energy that – depending on the particular application – is dissipated by a braking resistor. This superfluous energy is transformed into heat.

The internal braking resistor is designed for the NORDAC *FLEX* SK 200E series of units and depends on the mains voltage and the power. The internal brake resistor can be used for applications in which only slight, short braking phases are to be expected.



Technical Data

Electrical data

Number of leads		2
Resistance	Ω	200

Max. continuous power P_n 1)	W	200
Energy consumption P_{max} 2)	kWs	2.0

¹⁾ Reduction of the continuous power of the braking resistor to 25 % of the rated power.

²⁾ The stated value applies to a single use within 10 s.

General

Temperature range	°C	- 40 ... + 200
Tightening torque		
Screw	Nm	2.5 – 3.0
Weight	kg	0.09

Certifications	CE, RoHS, UL
Protection class	IP00
Mounting ¹⁾	
Hexagon socket screw	M4 x 12

¹⁾ The screw and the washer are included in the scope of delivery

Dimensions

Housing dimensions		
Total [mm]	W x H x D	69.5 x 55.0 x 6.8
Adapter plate [mm]	W x H x D	69.0 x 51.0 x 5.5
Heat conducting film [mm]	W x H x D	65.0 x 55.0 x 0.3
Resistance [mm]	W x H x D	69.5 x 51.5 x 1.0
Cable / line [mm]		
Lead blue / blue	L	60.0 / 60.0
Wire end sleeve	L	8.0

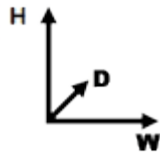

Connections

Name	+B	-B
Cross section / type	AWG 18	
Wire colour	Blue	Blue
Terminal label	Power terminal +B	Power terminal -B
Tightening torque SK 2xxE	1.2 – 1.5 Nm	

i Information

Versions

Due to the production process, various versions of braking resistor are available for installation and connection to *NORDAC FLEX* frequency inverters.



Older version

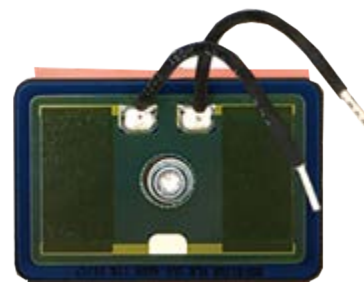

Current version

Frequency inverter assignment

i Information

Overview in the manual

The braking resistors provided by the NORD DRIVESYSTEMS Group are specially designed for the particular frequency inverters.

Otherwise, the internal braking resistor and the frequency inverter may be damaged during operation.

For detailed information, please refer to section  Assignment of Braking Resistors, in the relevant frequency inverter manual  "Further documentation and software: www.nord.com".

Installation

Installation location	Direct installation and connection to a decentralised <i>NORDAC FLEX</i> frequency inverter: <ul style="list-style-type: none"> In the connection unit of the frequency inverter
Installation orientation	Option slot 2
Fastening	With screws (fastening material is included)

i Information



Assembly sequence

To install or remove the internal braking resistor, a power terminal strip which must be removed from the connection unit.

For the use of Type SK CU4-... customer interfaces and depending on the type of device and the options used, further components may need to be removed.





With the motor mounted version, the motor cover / insulating plate must be correctly removed. In contrast, for a wall mounted version, no motor cover / insulating plate is installed in the connection unit.

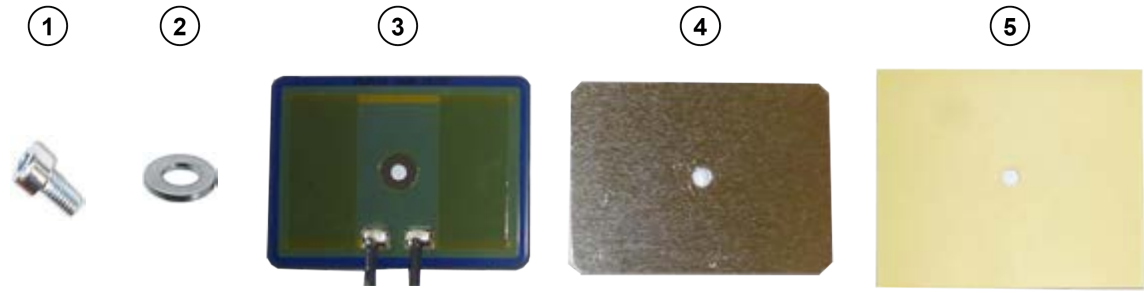
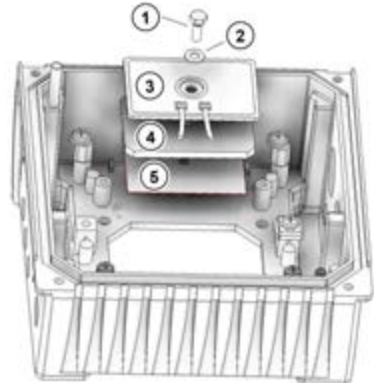

For detailed information regarding installation of the connection unit and the optional modules, please refer to section  Assembly and Installation, in the frequency inverter manual  "Further documentation and software: www.nord.com".

Installation steps

1.	Installing the frequency inverter The SK 2xxE frequency inverter is not yet installed on the SK T14 connection unit and the drive.	 <p>Motor mounted version</p>
2.	Installing the internal braking resistor The braking resistor is fastened to option slot 2 in the SK T14 connection unit. <ul style="list-style-type: none"> All components are installed in the connection unit using the enclosed M4 hexagon socket screw and the washer. 	

3.	 <p> ① Screw ② Washer ③ Resistor ④ Adapter plate ⑤ Heat conducting film </p>	<p> Attach the heat conducting film to the adapter plate with the self-adhesive film. </p> <ul style="list-style-type: none"> • Caution: For this, the protective film must be removed from the heat conducting film. • Then place the adapter plate with the heat conducting film facing downwards into option slot 2 • Place the braking resistor on the adapter plate in the connection unit with the connecting wires facing inwards • Insert the hexagon socket screw with the washer into the fastening hole of the braking resistor • Firmly screw the braking resistor and adapter plate / heat conducting film to the connection unit   <p> The specified tightening torques (see  Technical Data – General) must be complied with for fastening. </p>
4.	<p> Connect the two connection wires to the power terminal strip or to the terminals of the frequency inverter. </p> <p> Black lead ⇔ -B Black lead ⇔ +B </p> <p> Please heed the specified tightening torques; refer to  Technical Data – Connections. </p>	

Information

Peak load limitation - DIP switch (S1)

If a type SK BRI4-...internal braking resistor is used, the DIP switch (S1) DIP No., 8 see  "Further documentation and software: www.nord.com", must be set to "On". This is important in order to activate a peak power limitation to protect the braking resistor.

Parameters





For optimum operation of the internal braking resistor, no parameters of the frequency inverter need to be changed. Limitation of the peak load is carried out solely via the hardware using DIP switch S1 with DIP No. 8 set to the position "On". Refer to the frequency inverter manual for details  "Further documentation and software: www.nord.com".

Error messages

Error messages of the internal braking resistor – the current or the archived message of the last fault – can be retrieved using the information parameters Actual fault P700 and Last fault P701 from the error memory of the frequency inverter. Refer to the frequency inverter manual for details  "Further documentation and software: www.nord.com").

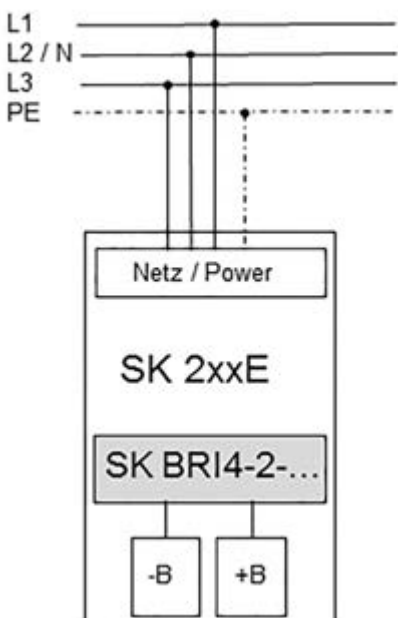
Error (E030/E050)	Meaning	Remarks
3.1	I ² t overcurrent limit	Brake chopper: I ² t limit has been triggered, 1.5x value for 60 s reached <ul style="list-style-type: none"> Avoid overcurrent in brake resistance
5.0	Overvoltage UZW	Link circuit voltage too high <ul style="list-style-type: none"> Check the function of the connected braking resistor (broken cable) Resistance value of connected braking resistor too high

Wiring diagram

	 <p>Internal brake resistor SK BRI4-2-x00-x00</p>
 <p>Size 3 SK 2xxE</p>	 <p>Connection unit SK TI4-3</p>

Further documentation and software: www.nord.com

Document	Designation
BU 0200	SK 200E frequency inverter manual

SK BRI4-3-047-300

Part number: 275 272 201

Internal braking resistor for connection to a
NORDAC FLEX SK 2xxE



Only qualified electricians are allowed to install and commission the module. An electrician is a person who, because of their technical training and experience, has sufficient knowledge with regard to

- switching on, switching off, isolating, earthing and marking power circuits and devices,
- proper maintenance and use of protective devices in accordance with defined safety standards.

DANGER!

Danger of electric shock

The frequency inverter continues to carry hazardous voltages for up to 5 minutes after it was switched off.

- Work must not be carried out unless the device has been disconnected from the voltage and at least 5 minutes have elapsed since the mains was switched off!

CAUTION

Danger of burns

The module and all other metal components can heat up to temperatures above 70 °C.

Sufficient cooling time must be allowed for when working on the components in order to avoid injuries (local burns) to parts of the body coming into contact with the components.

In order to avoid damage to neighbouring objects, sufficient clearance must be maintained during installation.

NOTICE

Validity of this document

This document is only valid in combination with the operating instructions for the relevant frequency inverter. Safe commissioning of this module and the frequency inverter depends on the availability of this information.

Technical Information / Datasheet	SK BRI4-3-047-300			
Brake resistor	TI 2752272201	1.0	3018	en

Scope of delivery

Module		
1 x	Braking resistor	SK BRI4-3
1 x	Fastening screw	M4 x 12 hexagon socket screw
1 x	Washer	A 4.3
1 x	Adapter plate	Aluminium, 7 mm
1 x	Heat conducting film	Thermo-silicone, 0.3 mm

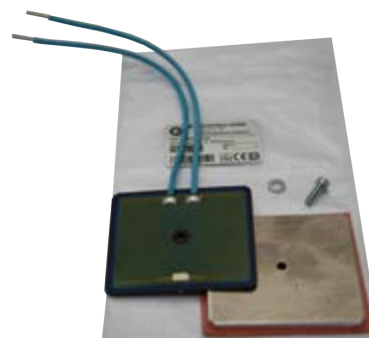

Field of use

Dynamic braking (frequency lowering) of a three-phase motor via a frequency inverter results in generator braking energy that – depending on the particular application – is dissipated by a braking resistor. This superfluous energy is transformed into heat.

The internal braking resistor is designed for the NORDAC *FLEX* SK 200E series of units and depends on the mains voltage and the power. The internal brake resistor can be used for applications in which only slight, short braking phases are to be expected.



Technical Data

Electrical data

Number of leads		2
Resistance	Ω	47

Max. continuous power P_n 1)	W	300
Energy consumption P_{max} 2)	kWs	3.0

¹⁾ Reduction of the continuous power of the braking resistor to 25 % of the rated power.

²⁾ The stated value applies to a single use within 10 s.

General

Temperature range	°C	- 40 ... + 200
Tightening torque Screw	Nm	2.5 – 3.0
Weight	kg	0.105

Certifications	CE, RoHS, UL
Protection class	IP00
Mounting ¹⁾ Hexagon socket screw	M4 x 12

¹⁾ The screw and the washer are included in the scope of delivery

Dimensions

Housing dimensions		
Total [mm]	W x H x D	75.0 x 67.0 x 8.8
Adapter plate [mm]	W x H x D	69.0 x 61.0 x 7.5
Heat conducting film [mm]	W x H x D	75.0 x 67.0 x 0.3
Resistance [mm]	W x H x D	69.5 x 51.5 x 1.0
Cable / line [mm]		
Lead blue / blue	L	170.0 / 170.0
Wire end sleeve	L	8.0

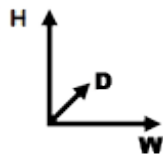

Connections

Name	+B	-B
Cross section / type	AWG 16	
Wire colour	Blue	Blue
Terminal label	Power terminal +B	Power terminal -B
Tightening torque SK 2xxE	1.2 – 1.5 Nm	

i Information

Versions

Due to the production process, various versions of braking resistor are available for installation and connection to *NORDAC FLEX* frequency inverters.



Older version

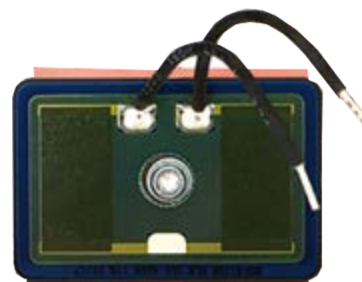



Current version

Frequency inverter assignment

i Information **Overview in the manual**

The braking resistors provided by the NORD DRIVESYSTEMS Group are specially designed for the particular frequency inverters.

Otherwise, the internal braking resistor and the frequency inverter may be damaged during operation.

For detailed information, please refer to section  Assignment of Braking Resistors, in the relevant frequency inverter manual  "Further documentation and software: www.nord.com".

Installation

Installation location	Direct installation and connection to a <i>NORDAC FLEX</i> frequency inverter: <ul style="list-style-type: none"> • In the connection unit of the frequency inverter
Installation orientation	Option slot 2 (right or left)
Fastening	With screws (fastening material included)



i Information **Assembly sequence**

A power terminal strip which has already been installed does **not necessarily** need to be removed from the connection unit in order to install or remove the internal braking resistor.

With the use of Type SK CU4-... customer interfaces and depending on the type of device and the options used, further components may need to be removed.





With the motor mounted version, the motor cover / insulating plate must be correctly removed. In contrast, for a wall mounted version, no motor cover / insulating plate is installed in the connection unit.

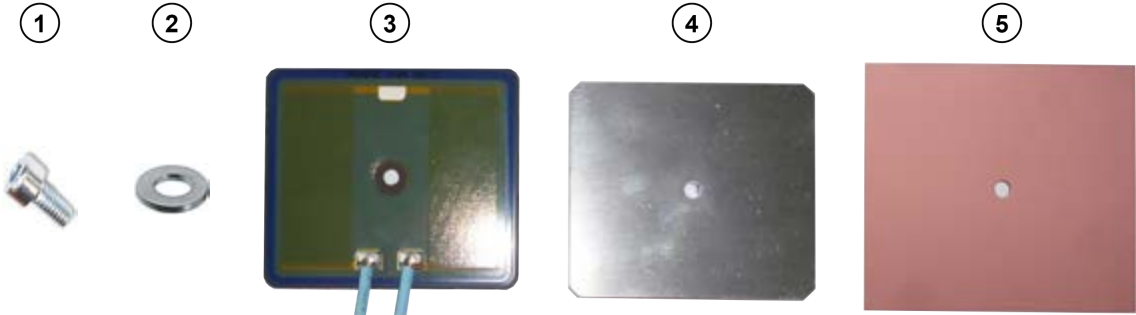
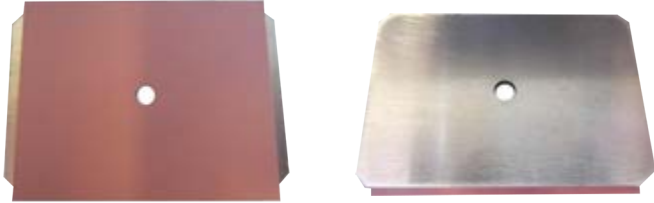

For detailed information regarding installation of the connection unit and the optional modules, please refer to section  Assembly and Installation, in the frequency inverter manual  "Further documentation and software: www.nord.com".

Installation steps

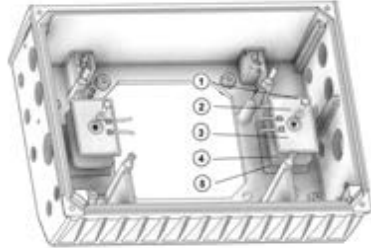
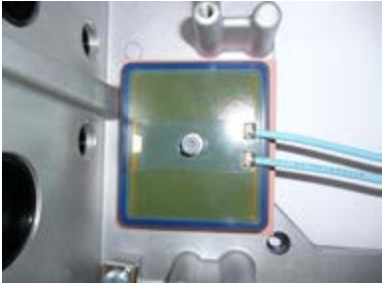
1.	Installing the frequency inverter The SK 2xxE frequency inverter has not yet been installed on the SK T14 connection unit and the drive.	
2.	Installing the internal braking resistor The braking resistor is fastened to option slot 2 (right or left) in the SK T14 connection unit. <ul style="list-style-type: none"> • All components are installed in the connection unit using the enclosed M4 hexagon socket screw and the washer. 	

3.	 <p> ① Screw ② Washer ③ Resistor ④ Adapter plate ⑤ Heat conducting film </p>	
	<p>Attach the heat conducting film to the adapter plate with the self-adhesive film.</p> <ul style="list-style-type: none"> • Caution: For this, the protective film must be removed from the heat conducting film. • Then place the adapter plate with the heat conducting film facing downwards into option slot 2 (right or left) • Place the braking resistor on the adapter plate in the connection unit with the connecting wires facing inwards • Insert the hexagon socket screw with the washer into the fastening hole of the braking resistor • Firmly screw the braking resistor and adapter plate / heat conducting film to the connection unit  <p>The specified tightening torques (see  Technical Data – General) must be complied with for fastening.</p>	 <p>Option slot 2 is available both on the right and the left</p> 
4.	<p>Connect the two connection wires to the power terminal strip or to the terminals of the frequency inverter.</p> <p> Blue lead ⇔ -B Blue lead ⇔ +B </p> <p>The specified tightening torques; refer to  Technical Data – Connections must be complied with.</p>	

Information

Peak load limitation - DIP switch (S1)

If a type SK BRI4-...internal braking resistor is used, the DIP switch (S1) DIP No., 8 see  "Further documentation and software: www.nord.com", must be set to "On". This is important in order to activate a peak power limitation to protect the braking resistor.

Parameters





For optimum operation of the internal braking resistor, no parameters of the frequency inverter need to be changed. Limitation of the peak load is carried out solely via the hardware using DIP switch S1 with DIP No. 8 set to the position "On". Refer to the frequency inverter manual for details  "Further documentation and software: www.nord.com".

Error messages

Error messages of the internal braking resistor – the current or the archived message of the last fault – can be retrieved using the information parameters Actual fault P700 and Last fault P701 from the error memory of the frequency inverter. Refer to the frequency inverter manual for details  "Further documentation and software: www.nord.com").

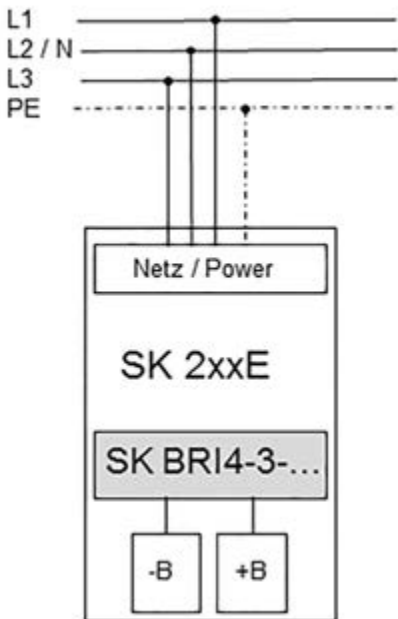
Error (E030/E050)	Meaning	Remarks
3.1	I^2t overcurrent limit	Brake chopper: I^2t limit has been triggered, 1.5x value for 60 s reached <ul style="list-style-type: none"> Avoid overcurrent in brake resistance
5.0	Overvoltage UZW	Link circuit voltage too high <ul style="list-style-type: none"> Check the function of the connected braking resistor (broken cable) Resistance value of connected braking resistor too high

Wiring diagram

	 <p style="text-align: center;">Internal brake resistor SK BRI4-3-xxx-300</p>
 <p style="text-align: center;">Size 4 SK 2xxE</p>	 <p style="text-align: center;">Connection unit SK TI4-4</p>

Further documentation and software: www.nord.com

Document	Designation
BU 0200	SK 200E frequency inverter manual

SK BRI4-3-100-300

Part number: 275 272 205

Internal braking resistor for connection to a
NORDAC FLEX SK 2xxE



Only qualified electricians are allowed to install and commission the module. An electrician is a person who, because of their technical training and experience, has sufficient knowledge with regard to

- switching on, switching off, isolating, earthing and marking power circuits and devices,
- proper maintenance and use of protective devices in accordance with defined safety standards.

DANGER!

Danger of electric shock

The frequency inverter continues to carry hazardous voltages for up to 5 minutes after it was switched off.

- Work must not be carried out unless the device has been disconnected from the voltage and at least 5 minutes have elapsed since the mains was switched off!

CAUTION

Danger of burns

The module and all other metal components can heat up to temperatures above 70 °C.

Sufficient cooling time must be allowed for when working on the components in order to avoid injuries (local burns) to parts of the body coming into contact with the components.

In order to avoid damage to neighbouring objects, sufficient clearance must be maintained during installation.

NOTICE

Validity of this document

This document is only valid in combination with the operating instructions for the relevant frequency inverter. Safe commissioning of this module and the frequency inverter depends on the availability of this information.

Technical Information / Datasheet	SK BRI4-3-100-300			
Brake resistor	TI 2752272205	1.0	3018	en

Scope of delivery

Module		
1 x	Braking resistor	SK BRI4-3
1 x	Fastening screw	M4 x 12 hexagon socket screw
1 x	Washer	A 4.3
1 x	Adapter plate	Aluminium, 7 mm
1 x	Heat conducting film	Thermo-silicone, 0.3 mm

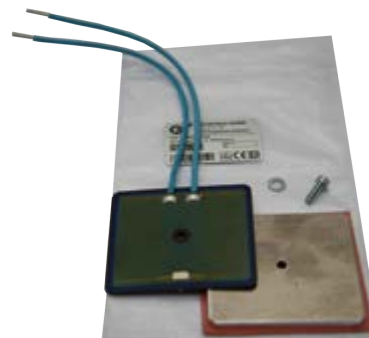

Field of use

Dynamic braking (frequency lowering) of a three-phase motor via a frequency inverter results in generator braking energy that – depending on the particular application – is dissipated by a braking resistor. This superfluous energy is transformed into heat.

The internal braking resistor is designed for the NORDAC *FLEX* SK 200E series of units and depends on the mains voltage and the power. The internal brake resistor can be used for applications in which only slight, short braking phases are to be expected.



Technical Data

Electrical data

Number of leads		2
Resistance	Ω	100

Max. continuous power P_n 1)	W	300
Energy consumption P_{max} 2)	kWs	3.0

¹⁾ Reduction of the continuous power of the braking resistor to 25 % of the rated power.

²⁾ The stated value applies to a single use within 10 s.

General

Temperature range	°C	- 40 ... + 200
Tightening torque		
Screw	Nm	2.5 – 3.0
Weight	kg	0.105

Certifications	CE, RoHS, UL	
Protection class	IP00	
Mounting ¹⁾		
Hexagon socket screw	M4 x 12	

¹⁾ The screw and the washer are included in the scope of delivery

Dimensions

Housing dimensions		
Total [mm]	W x H x D	75.0 x 67.0 x 8.8
Adapter plate [mm]	W x H x D	69.0 x 61.0 x 7.5
Heat conducting film [mm]	W x H x D	75.0 x 67.0 x 0.3
Resistance [mm]	W x H x D	69.5 x 51.5 x 1.0
Cable / line [mm]		
Lead blue / blue	L	170.0 / 170.0
Wire end sleeve	L	8.0

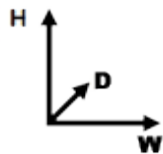

Connections

Name	+B	-B
Cross section / type	AWG 16	
Wire colour	Blue	Blue
Terminal label	Power terminal +B	Power terminal -B
Tightening torque SK 2xxE	1.2 – 1.5 Nm	

i Information

Versions

Due to the production process, various versions of braking resistor are available for installation and connection to *NORDAC FLEX* frequency inverters.



Older version

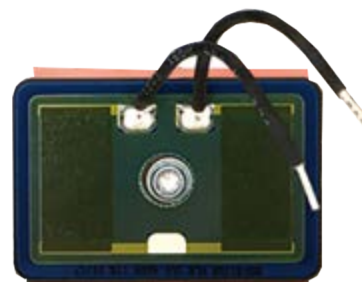

Current version



Frequency inverter assignment

i Information

Overview in the manual

The braking resistors provided by the NORD DRIVESYSTEMS Group are specially designed for the particular frequency inverters.

Otherwise, the internal braking resistor and the frequency inverter may be damaged during operation.

For detailed information, please refer to section  Assignment of Braking Resistors, in the relevant frequency inverter manual  "Further documentation and software: www.nord.com".

Installation

Installation location	Direct installation and connection to a <i>NORDAC FLEX</i> frequency inverter: <ul style="list-style-type: none"> In the connection unit of the frequency inverter
Installation orientation	Option slot 2 (right or left)
Fastening	With screws (fastening material included)

i Information



Assembly sequence

A power terminal strip which has already been installed does **not necessarily** need to be removed from the connection unit in order to install or remove the internal braking resistor.

With the use of Type SK CU4-... customer interfaces and depending on the type of device and the options used, further components may need to be removed.









With the motor mounted version, the motor cover / insulating plate must be correctly removed. In contrast, for a wall mounted version, no motor cover / insulating plate is installed in the connection unit.

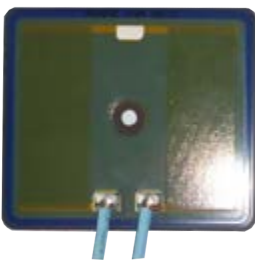

For detailed information regarding installation of the connection unit and the optional modules, please refer to section  Assembly and Installation, in the frequency inverter manual  "Further documentation and software: www.nord.com".

Installation steps

1.	Installing the frequency inverter The SK 2xxE frequency inverter has not yet been installed on the SK T14 connection unit and the drive.	
2.	Installing the internal braking resistor The braking resistor is fastened to option slot 2 (right or left) in the SK T14 connection unit. <ul style="list-style-type: none"> All components are installed in the connection unit using the enclosed M4 hexagon socket screw and the washer. 	

3.	<div style="display: flex; justify-content: space-around; text-align: center;"> <div style="width: 15%;">  <p>1</p> </div> <div style="width: 15%;">  <p>2</p> </div> <div style="width: 15%;">  <p>3</p> </div> <div style="width: 15%;">  <p>4</p> </div> <div style="width: 15%;">  <p>5</p> </div> </div> <div style="display: flex; justify-content: space-around; margin-top: 10px;"> Screw Washer Resistor Adapter plate Heat conducting film </div>
	<p>Attach the heat conducting film to the adapter plate with the self-adhesive film.</p> <ul style="list-style-type: none"> • Caution: For this, the protective film must be removed from the heat conducting film. • Then place the adapter plate with the heat conducting film facing downwards into option slot 2 (right or left) • Place the braking resistor on the adapter plate in the connection unit with the connecting wires facing inwards • Insert the hexagon socket screw with the washer into the fastening hole of the braking resistor • Firmly screw the braking resistor and adapter plate / heat conducting film to the connection unit <div style="display: flex; justify-content: space-around; margin-top: 10px;">   </div> <p>The specified tightening torques (see  Technical Data – General) must be complied with for fastening.</p>
4.	<p>Connect the two connection wires to the power terminal strip or to the terminals of the frequency inverter.</p> <p style="margin-left: 20px;">Blue lead ⇔ -B Blue lead ⇔ +B</p> <p>The specified tightening torques; refer to  Technical Data – Connections must be complied with.</p>

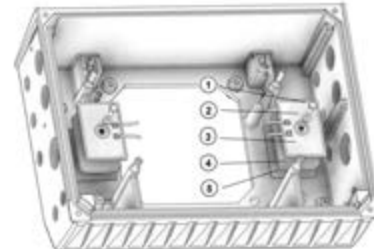

Option slot 2 is available both on the right and the left

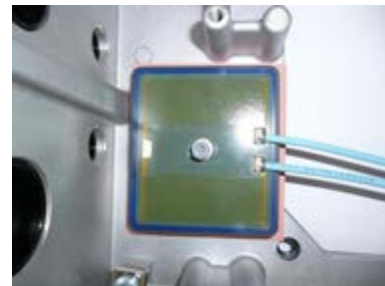

Information

Peak load limitation - DIP switch (S1)

If a type SK BRI4-...internal braking resistor is used, the DIP switch (S1) DIP No., 8 see  "Further documentation and software: www.nord.com", must be set to "On". This is important in order to activate a peak power limitation to protect the braking resistor.

Parameters





For optimum operation of the internal braking resistor, no parameters of the frequency inverter need to be changed. Limitation of the peak load is carried out solely via the hardware using DIP switch S1 with DIP No. 8 set to the position "On". Refer to the frequency inverter manual for details  "Further documentation and software: www.nord.com".

Error messages

Error messages of the internal braking resistor – the current or the archived message of the last fault – can be retrieved using the information parameters Actual fault P700 and Last fault P701 from the error memory of the frequency inverter. Refer to the frequency inverter manual for details  "Further documentation and software: www.nord.com").

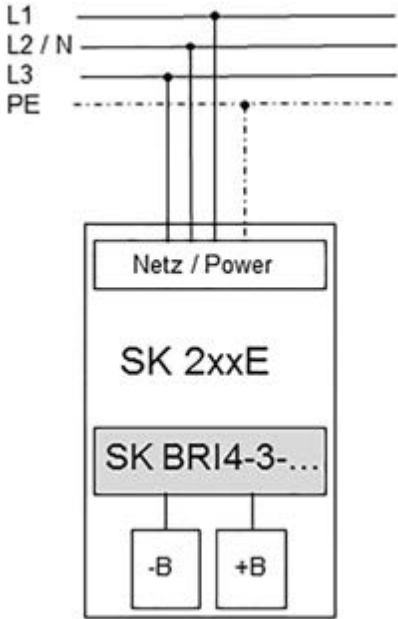
Error (E030/E050)	Meaning	Remarks
3.1	I ² t overcurrent limit	Brake chopper: I ² t limit has been triggered, 1.5x value for 60 s reached <ul style="list-style-type: none"> Avoid overcurrent in brake resistance
5.0	Overvoltage UZW	Link circuit voltage too high <ul style="list-style-type: none"> Check the function of the connected braking resistor (broken cable) Resistance value of connected braking resistor too high

Wiring diagram

	 <p style="text-align: center;">Internal brake resistor SK BRI4-3-xxx-300</p>	
 <p style="text-align: center;">Size 4 SK 2xxE</p>	 <p style="text-align: center;">Connection unit SK TI4-4</p>	

Further documentation and software: www.nord.com

Document	Designation
BU_0200	SK 200E frequency inverter manual

SK BRI4-3-023-600

Part number: 275 272 800

Internal braking resistor (set) for connection to a
NORDAC FLEX SK 2xxE



Only qualified electricians are allowed to install and commission the module. An electrician is a person who, because of their technical training and experience, has sufficient knowledge with regard to

- switching on, switching off, isolating, earthing and marking power circuits and devices,
- proper maintenance and use of protective devices in accordance with defined safety standards.

DANGER!

Danger of electric shock

The frequency inverter continues to carry hazardous voltages for up to 5 minutes after it was switched off.

- Work must not be carried out unless the device has been disconnected from the voltage and at least 5 minutes have elapsed since the mains was switched off!

CAUTION

Danger of burns

The module and all other metal components can heat up to temperatures above 70 °C.

Sufficient cooling time must be allowed for when working on the components in order to avoid injuries (local burns) to parts of the body coming into contact with the components.

In order to avoid damage to neighbouring objects, sufficient clearance must be maintained during installation.

NOTICE

Validity of this document

This document is only valid in combination with the operating instructions for the relevant frequency inverter. Safe commissioning of this module and the frequency inverter depends on the availability of this information.

Information

Set consisting of 2 braking resistors

For the individual power ranges of **Size 4** of the *NORDAC FLEX*, the item consists of a **set of 2 identical braking resistors**. These must be connected in **parallel** and thereby achieve the electrical data from the description of the part or the technical data  "Technical Data".

The installation location for the 2nd In the connection unit, the braking resistor is opposite the installation location of the 1st braking resistor. For detailed information please refer to Section  "Installation".

Technical Information / Datasheet		SK BRI4-3-023-600			
Brake resistor		TI 2752272800	1.0	3018	en

Scope of delivery

Module		
2 x	Braking resistor	SK BRI4-3
2 x	Fastening screw	M4 x 12 hexagon socket screw
2 x	Washer	A 4.3
2 x	Adapter plate	Aluminium, 7 mm
2 x	Heat conducting film	Thermo-silicone, 0.3 mm



Field of use

Dynamic braking (frequency lowering) of a three-phase motor using a frequency inverter results in generator braking energy that – depending on the application case – is dissipated by a braking resistor. This superfluous energy is transformed into heat.

The two internal braking resistors are designed for the NORDAC *FLEX* SK 200E series of units and depends on the mains voltage and the power. The set consisting of the two internal braking resistors can be used for applications in which only slight, short braking phases are to be expected.



Technical Data

Electrical data

Number of leads		2 x 2
Resistance	Ω	23

Max. continuous power P_n 1)	W	600
Energy consumption P_{max} 2)	kWs	6.0

¹⁾ Reduction of the continuous power of the braking resistor to 25 % of the rated power.

²⁾ The stated value applies to a single use within 10 s.

General

Temperature range	$^{\circ}\text{C}$	- 40 ... + 200
Tightening torque Screw	Nm	2.5 – 3.0
Weight	kg	0.21

Certifications	CE, RoHS, UL	
Protection class	IP00	
Mounting ¹⁾ Hexagon socket screw	2 x M4 x 12	

¹⁾ The screw and the washer are included in the scope of delivery

Dimensions

Housing dimensions		
Total [mm]	W x H x D	75.0 x 67.0 x 8.8
Adapter plate [mm]	W x H x D	69.0 x 61.0 x 7.5
Heat conducting film [mm]	W x H x D	75.0 x 67.0 x 0.3
Resistance [mm]	W x H x D	69.5 x 51.5 x 1.0
Cable / line [mm]		
Lead blue / blue	L	170.0 / 170.0
Wire end sleeve	L	8.0

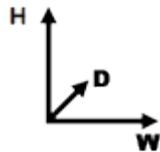
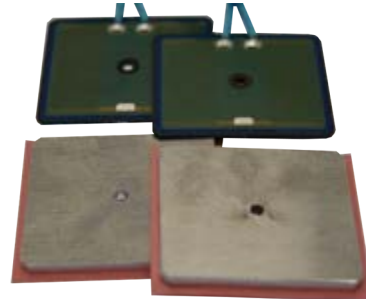

Connections

Name	+B	-B
Cross section / type	AWG 16	
Wire colour	Blue	Blue
Terminal label	Power terminal +B	Power terminal -B
Tightening torque SK 2xxE	1.2 – 1.5 Nm	

i Information

Versions

Due to the production process, various versions of braking resistor are available for installation and connection to *NORDAC FLEX* frequency inverters.



Older version

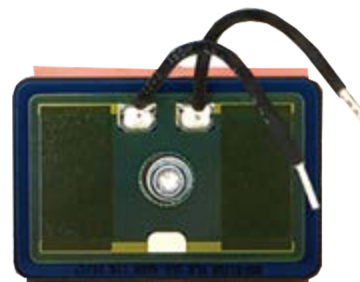

Current version

Frequency inverter assignment

i Information

Overview in the manual

The braking resistors provided by the NORD DRIVESYSTEMS Group are specially designed for the particular frequency inverters.

Otherwise, the internal braking resistor and the frequency inverter may be damaged during operation.

For detailed information, please refer to section  Assignment of Braking Resistors, in the relevant frequency inverter manual  "Further documentation and software: www.nord.com".

Installation

Installation location	Direct installation and connection to a <i>NORDAC FLEX</i> frequency inverter: <ul style="list-style-type: none"> In the connection unit of the frequency inverter
Installation orientation	Option slot 2 (right and left)
Fastening	With screws (fastening material is included)

i Information



Assembly sequence

A power terminal strip which has already been installed does **not necessarily** need to be removed from the connection unit in order to install or remove the two internal braking resistors.

For the use of Type SK CU4-... customer interfaces and depending on the type of device and the options used, further components may need to be removed.





With the motor mounted version, the motor cover / insulating plate must be correctly removed. In contrast, for a wall mounted version, no motor cover / insulating plate is installed in the connection unit.

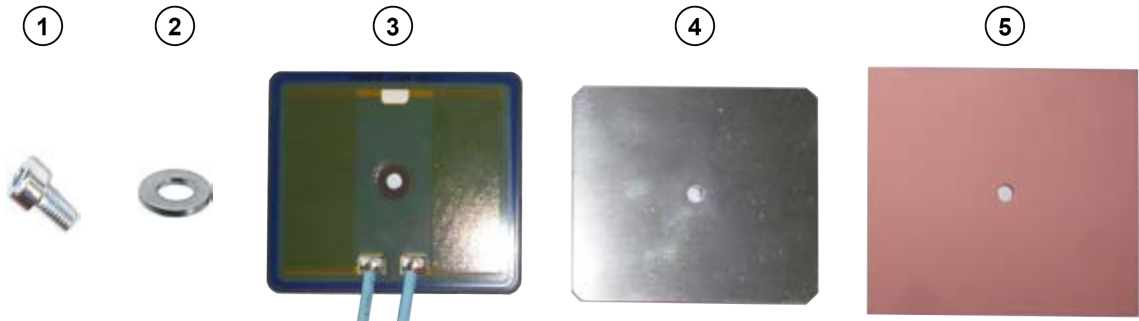
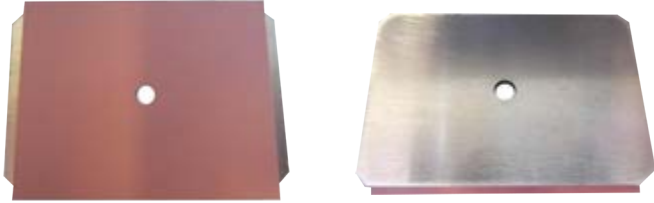

For detailed information regarding installation of the connection unit and the optional modules, please refer to section  Assembly and Installation, in the frequency inverter manual  "Further documentation and software: www.nord.com".

Installation steps

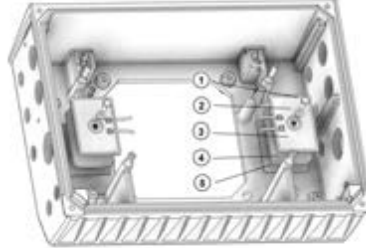
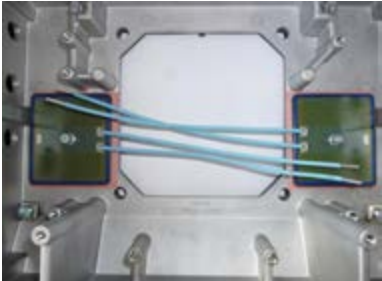
1.	<p>Installing the frequency inverter</p> <p>The SK 2xxE frequency inverter is not yet installed on the SK T14 connection unit and the drive.</p>	
2.	<p>Installing the internal braking resistor</p> <p>The two braking resistors are fastened to option slot 2 (right and left) in the SK T14 connection unit.</p> <ul style="list-style-type: none"> All components are installed in the connection unit using the enclosed M4 hexagon socket screws and the washers. 	

3.	 <p> 2 x Screws 2 x Washers 2 x Resistors 2 x Adapter plates 2 x Heat conducting films </p>	
	<p>Attach the heat conducting film to the adapter plate with the self-adhesive side of the film.</p> <ul style="list-style-type: none"> • Caution: For this, the protective film must be removed from the heat conducting film. • Then place the adapter plate with the heat conducting film facing downwards into option slot 2 (right and left) • Place the braking resistors on the adapter plates in the connection unit with the connecting wires facing inwards • Insert the hexagon socket screw with the washer into the fastening hole of the braking resistor • Firmly screw the braking resistor and adapter plates / heat conducting films to the connection unit  <p>The specified tightening torques (see  Technical Data – General) must be complied with for fastening.</p>	 <p>Option slot 2 is available both on the right and the left</p> 
4.	<p>The two connection wires from the braking resistors are connected in parallel to the power terminal strip or the terminals of the frequency inverter.</p> <p> Blue lead ⇔ -B Blue lead ⇔ +B </p> <p>Please observe the specified tightening torques; refer to  Technical Data – Connections.</p>	

Information

Peak load limitation - DIP switch (S1)

If a type SK BRI4-...internal braking resistor is used, the DIP switch (S1) DIP No., 8 see  "Further documentation and software: www.nord.com", must be set to "On". This is important in order to activate a peak power limitation to protect the braking resistor.

Parameters





For optimum operation of the internal braking resistor, no parameters of the frequency inverter need to be changed. Limitation of the peak load is carried out solely via the hardware using DIP switch S1 with DIP No. 8 set to the position "On". Refer to the frequency inverter manual for details  "Further documentation and software: www.nord.com".

Error messages

Error messages of the internal braking resistor – the current or the archived message of the last fault – can be retrieved using the information parameters Actual fault P700 and Last fault P701 from the error memory of the frequency inverter. Refer to the frequency inverter manual for details  "Further documentation and software: www.nord.com").

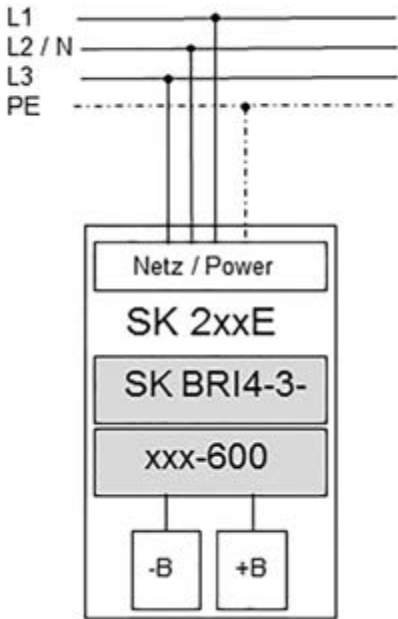
Error (E030/E050)	Meaning	Remarks
3.1	I^2t overcurrent limit	Brake chopper: I^2t limit has been triggered, 1.5x value for 60 s reached <ul style="list-style-type: none"> Avoid overcurrent in brake resistance
5.0	Overvoltage UZW	Link circuit voltage too high <ul style="list-style-type: none"> Check the function of the connected braking resistor (broken cable) Resistance value of connected braking resistor too high

Wiring diagram

	 <p style="text-align: center;">Internal braking resistor (set) SK BRI4-3-xxx-600</p>
 <p style="text-align: center;">Size 4 SK 2xxE</p>	 <p style="text-align: center;">Connection unit SK TI4-4</p>

Further documentation and software: www.nord.com

Document	Designation
BU_0200	SK 200E frequency inverter manual

SK BRI4-3-050-600

Part number: 275 272 801

Internal braking resistor (set) for connection to a
NORDAC FLEX SK 2xxE



Only qualified electricians are allowed to install and commission the module. An electrician is a person who, because of their technical training and experience, has sufficient knowledge with regard to

- switching on, switching off, isolating, earthing and marking power circuits and devices,
- proper maintenance and use of protective devices in accordance with defined safety standards.

DANGER!

Danger of electric shock

The frequency inverter continues to carry hazardous voltages for up to 5 minutes after it was switched off.

- Work must not be carried out unless the device has been disconnected from the voltage and at least 5 minutes have elapsed since the mains was switched off!

CAUTION

Danger of burns

The module and all other metal components can heat up to temperatures above 70 °C.

Sufficient cooling time must be allowed for when working on the components in order to avoid injuries (local burns) to parts of the body coming into contact with the components.

In order to avoid damage to neighbouring objects, sufficient clearance must be maintained during installation.

NOTICE

Validity of this document

This document is only valid in combination with the operating instructions for the relevant frequency inverter. Safe commissioning of this module and the frequency inverter depends on the availability of this information.

Information

Set consisting of 2 braking resistors

For the individual power ranges of **Size 4** of the *NORDAC FLEX*, the item consists of a **set of 2 identical braking resistors**. These must be connected in **parallel** and thereby achieve the electrical data from the description of the part or the technical data  "Technical Data".

The installation location for the 2nd In the connection unit, the braking resistor is opposite the installation location of the 1st braking resistor. For detailed information please refer to Section  "Installation".

Technical Information / Datasheet		SK BRI4-3-050-600			
Brake resistor		TI 2752272801	1.0	3018	en

Scope of delivery

Module		
2 x	Braking resistor	SK BRI4-3
2 x	Fastening screw	M4 x 12 hexagon socket screw
2 x	Washer	A 4.3
2 x	Adapter plate	Aluminium, 7 mm
2 x	Heat conducting film	Thermo-silicone, 0.3 mm



Field of use

Dynamic braking (frequency lowering) of a three-phase motor using a frequency inverter results in generator braking energy that – depending on the application case – is dissipated by a braking resistor. This superfluous energy is transformed into heat.

The two internal braking resistors are designed for the NORDAC *FLEX* SK 200E series of units and depends on the mains voltage and the power. The set consisting of the two internal braking resistors can be used for applications in which only slight, short braking phases are to be expected.



Technical Data

Electrical data

Number of leads		2 x 2
Resistance	Ω	50

Max. continuous power P_n 1)	W	600
Energy consumption P_{max} 2)	kWs	6.0

¹⁾ Reduction of the continuous power of the braking resistor to 25 % of the rated power.

²⁾ The stated value applies to a single use within 10 s.

General

Temperature range	$^{\circ}\text{C}$	- 40 ... + 200
Tightening torque		
Screw	Nm	2.5 – 3.0
Weight	kg	0.21

Certifications	CE, RoHS, UL	
Protection class	IP00	
Mounting ¹⁾		
Hexagon socket screw	2 x M4 x 12	

¹⁾ The screw and the washer are included in the scope of delivery

Dimensions

Housing dimensions		
Total [mm]	W x H x D	75.0 x 67.0 x 8.8
Adapter plate [mm]	W x H x D	69.0 x 61.0 x 7.5
Heat conducting film [mm]	W x H x D	75.0 x 67.0 x 0.3
Resistance [mm]	W x H x D	69.5 x 51.5 x 1.0
Cable / line [mm]		
Lead blue / blue	L	170.0 / 170.0
Wire end sleeve	L	8.0

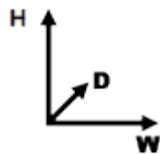
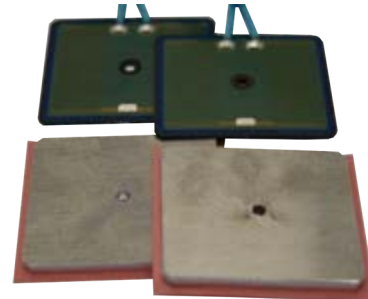

Connections

Name	+B	-B
Cross section / type	AWG 16	
Wire colour	Blue	Blue
Terminal label	Power terminal +B	Power terminal -B
Tightening torque SK 2xxE	1.2 – 1.5 Nm	

i Information

Versions

Due to the production process, various versions of braking resistor are available for installation and connection to *NORDAC FLEX* frequency inverters.



Older version

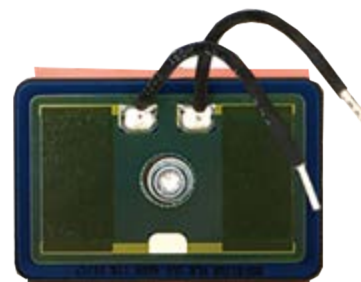

Current version



Frequency inverter assignment

i Information

Overview in the manual

The braking resistors provided by the NORD DRIVESYSTEMS Group are specially designed for the particular frequency inverters.

Otherwise, the internal braking resistor and the frequency inverter may be damaged during operation.

For detailed information, please refer to section  Assignment of Braking Resistors, in the relevant frequency inverter manual  "Further documentation and software: www.nord.com".

Installation

Installation location	Direct installation and connection to a <i>NORDAC FLEX</i> frequency inverter: <ul style="list-style-type: none"> In the connection unit of the frequency inverter
Installation orientation	Option slot 2 (right and left)
Fastening	With screws (fastening material is included)

i Information



Assembly sequence

A power terminal strip which has already been installed does **not necessarily** need to be removed from the connection unit in order to install or remove the two internal braking resistors.

For the use of Type SK CU4-... customer interfaces and depending on the type of device and the options used, further components may need to be removed.











With the motor mounted version, the motor cover / insulating plate must be correctly removed. In contrast, for a wall mounted version, no motor cover / insulating plate is installed in the connection unit.

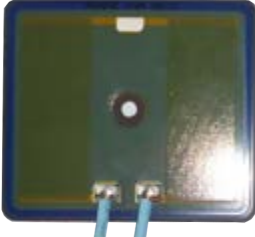

For detailed information regarding installation of the connection unit and the optional modules, please refer to section  Assembly and Installation, in the frequency inverter manual  "Further documentation and software: www.nord.com".

Installation steps

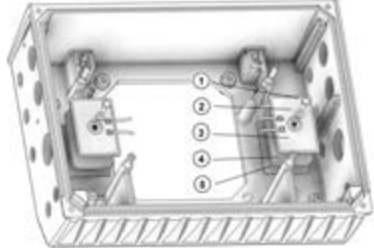
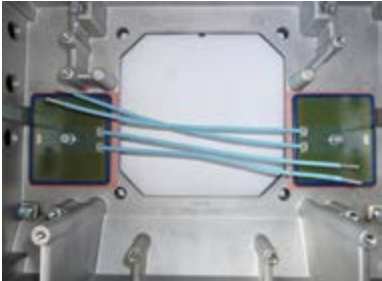
1.	Installing the frequency inverter	
The SK 2xxE frequency inverter is not yet installed on the SK T14 connection unit and the drive.		
2.	Installing the internal braking resistor	
The two braking resistors are fastened to option slot 2 (right and left) in the SK T14 connection unit.		
<ul style="list-style-type: none"> All components are installed in the connection unit using the enclosed M4 hexagon socket screws and the washers. 		

3.	<div style="display: flex; justify-content: space-around; align-items: center;"> <div style="text-align: center;">  <p>2 x Screws</p> </div> <div style="text-align: center;">  <p>2 x Washers</p> </div> <div style="text-align: center;">  <p>2 x Resistors</p> </div> <div style="text-align: center;">  <p>2 x Adapter plates</p> </div> <div style="text-align: center;">  <p>2 x Heat conducting films</p> </div> </div>	
	<p>Attach the heat conducting film to the adapter plate with the self-adhesive side of the film.</p> <ul style="list-style-type: none"> • Caution: For this, the protective film must be removed from the heat conducting film. • Then place the adapter plate with the heat conducting film facing downwards into option slot 2 (right and left) • Place the braking resistors on the adapter plates in the connection unit with the connecting wires facing inwards • Insert the hexagon socket screw with the washer into the fastening hole of the braking resistor • Firmly screw the braking resistor and adapter plates / heat conducting films to the connection unit <div style="display: flex; justify-content: space-around; align-items: center;">   </div> <p>The specified tightening torques (see  Technical Data – General) must be complied with for fastening.</p>	 <p>Option slot 2 is available both on the right and the left</p> 
4.	<p>The two connection wires from the braking resistors are connected in parallel to the power terminal strip or the terminals of the frequency inverter.</p> <p style="margin-left: 20px;">Blue lead ⇔ -B Blue lead ⇔ +B</p> <p>Please observe the specified tightening torques; refer to  Technical Data – Connections.</p>	

Information

Peak load limitation - DIP switch (S1)

If a type SK BRI4-...internal braking resistor is used, the DIP switch (S1) DIP No., 8 see  "Further documentation and software: www.nord.com", must be set to "On". This is important in order to activate a peak power limitation to protect the braking resistor.

Parameters



For optimum operation of the internal braking resistor, no parameters of the frequency inverter need to be changed. Limitation of the peak load is carried out solely via the hardware using DIP switch S1 with DIP No. 8 set to the position "On". Refer to the frequency inverter manual for details  "Further documentation and software: www.nord.com".

Error messages

Error messages of the internal braking resistor – the current or the archived message of the last fault – can be retrieved using the information parameters Actual fault P700 and Last fault P701 from the error memory of the frequency inverter. Refer to the frequency inverter manual for details  "Further documentation and software: www.nord.com").

Error (E030/E050)	Meaning	Remarks
3.1	I ² t overcurrent limit	Brake chopper: I ² t limit has been triggered, 1.5x value for 60 s reached <ul style="list-style-type: none"> Avoid overcurrent in brake resistance
5.0	Overvoltage UZW	Link circuit voltage too high <ul style="list-style-type: none"> Check the function of the connected braking resistor (broken cable) Resistance value of connected braking resistor too high

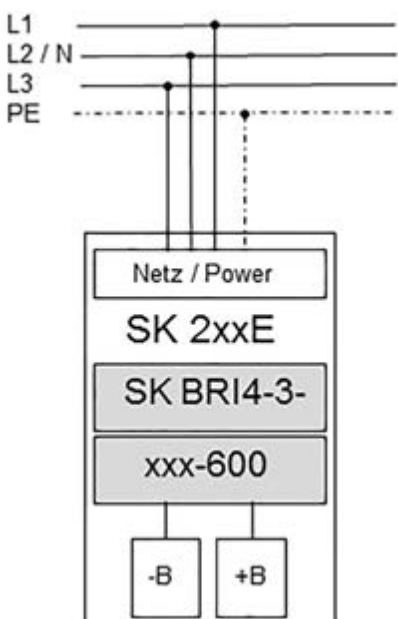
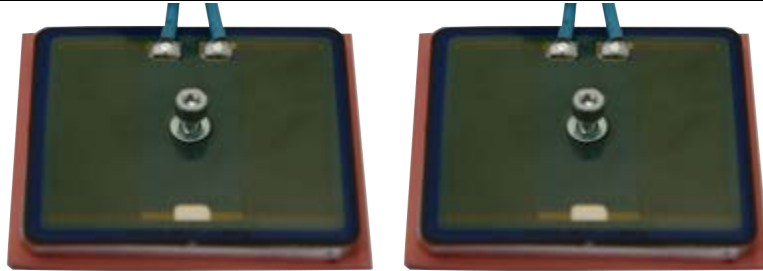
Wiring diagram

	 <p style="text-align: center;">Internal braking resistor (set) SK BRI4-3-xxx-600</p>
 <p style="text-align: center;">Size 4 SK 2xxE</p>	 <p style="text-align: center;">Connection unit SK TI4-4</p>

Further documentation and software: www.nord.com

Document	Designation
BU 0200	SK 200E frequency inverter manual