

# GETRIEBEBAU NORD

Member of the NORD DRIVESYSTEMS Group



Getriebebau NORD GmbH & Co. KG

Getriebebau-Nord-Straße 1 • 22941 Bargteheide, Germany • www.nord.com

## SK CU4-PBR-C

Part number: 275 271 500

### PROFIBUS® DP – Internal Bus Interface

The bus interface may only be installed and commissioned by qualified electricians. An electrician is a person who, because of their technical training and experience, has sufficient knowledge with regard to

- Switching on, switching off, isolating, earthing and marking power circuits and devices,
- Proper maintenance and use of protective devices in accordance with defined safety standards.



### Danger of electric shock

The frequency inverter carries hazardous voltage for up to 5 minutes after being switched off.

- Work must not be carried out unless the frequency inverter has been disconnected from the voltage and at least 5 minutes has elapsed since the mains was switched off.

### Validity of document

This document is only valid in conjunction with the operating instructions of the respective frequency inverter and the bus communication manual for this bus interface (📖 See overview at end of document). These documents contain all of the information that is required for safe commissioning of the bus interface module and the frequency inverter.

### Scope of delivery

1 x	Bus interface	SK CU4-PBR-C
1 x	System bus cable set	grey/black
1 x	24 VDC cable set	brown/blue
2 x	Connecting screws	M4 x 20, cross-head



### Usage area

Internal interface for the connection of a decentralised frequency inverter (NORDAC *BASE*, NORDAC *FLEX*, NORDAC *LINK*) to a **PROFIBUS DP** field bus. This is connected to the inverter via the system bus, and can directly access up to 4 frequency inverters. 2 digital inputs are available. The bus interface has a water-repellent coating. Reliable operation is retained even with condensation.

Technical Information / Datasheet	SK CU4-PBR-C			
PROFIBUS DP Bus module	TI 275271500	V 1.3	0623	en

## Technical Data

### Bus interface

Temperature range	-25 °C...50 °C	Vibration resistance	3M7
Temperature class	Class 3K3	Protection class	IP20
		Supply voltage	24 V ± 20 %, ≈ 90 mA Reverse polarity protected

Digital input - working range	Low: 0 V ... 5 V, High: 15 V ... 30 V
Digital input - specific data	R <sub>i</sub> = 8.1 kΩ, input capacity: 10 nF, response time 1 ms, inputs as per EN 61131-2 type 1

### Bus specification

PROFIBUS DP	Max. 12 MBit/s electrical isolation 500 V <sub>eff</sub>								
Bus connection	Screw terminals								
Bus termination	via DIP switch on the bus interface								
Status display	6 LEDs								
Topology	Linear bus								
Power setting	PROFIBUS DP-V1								
Cable	Cable type A according to EN 50170 (drilled, shielded two conductor cable)								
Cable length	depending on transmission speed: <table border="1" data-bbox="470 1169 933 1294"> <thead> <tr> <th>Bus cable length</th> <th>Transfer rate</th> </tr> </thead> <tbody> <tr> <td>400 m</td> <td>500 KBit/s</td> </tr> <tr> <td>200 m</td> <td>1500 KBit/s</td> </tr> <tr> <td>100 m</td> <td>3...12 MBit/s</td> </tr> </tbody> </table>	Bus cable length	Transfer rate	400 m	500 KBit/s	200 m	1500 KBit/s	100 m	3...12 MBit/s
Bus cable length	Transfer rate								
400 m	500 KBit/s								
200 m	1500 KBit/s								
100 m	3...12 MBit/s								
Shield	Direct to PE								
PE connection	via PE screw cap in terminal box								

### Power

Update interval for process data between bus interface and frequency inverter	≥ 5 ms
Parameter read access on the frequency inverter	≈ 12 ms
Parameter write access with storage in EEPROM	≈ 25 ms

**Bus interface characteristics**

Communication Performance levels DP-V0	Cyclic useful data connection between DP master and DP slaves (point-to-point useful data communication or Multicast)						
Communication Performance levels DP-V1	Acyclic data communication between DP master DPM1 and DP slaves						
Transfer Method	RS485						
Addressing	<table border="1"> <thead> <tr> <th>SK TU3-PBR</th> <th>SK TU3-PBR-24V</th> <th>SK xU4-PBR</th> </tr> </thead> <tbody> <tr> <td>Parameter <b>P508</b> at frequency inverter</td> <td>Rotary coding switch or parameter <b>P508</b> at frequency inverter</td> <td>DIP switch or parameter <b>P160</b></td> </tr> </tbody> </table>	SK TU3-PBR	SK TU3-PBR-24V	SK xU4-PBR	Parameter <b>P508</b> at frequency inverter	Rotary coding switch or parameter <b>P508</b> at frequency inverter	DIP switch or parameter <b>P160</b>
	SK TU3-PBR	SK TU3-PBR-24V	SK xU4-PBR				
Parameter <b>P508</b> at frequency inverter	Rotary coding switch or parameter <b>P508</b> at frequency inverter	DIP switch or parameter <b>P160</b>					
Synchronisation	Sync mode (synchronisation of outputs) and Freeze mode (synchronisation of inputs)						
Bus access	Token Passing procedure Master/Slave procedure Mono-Master or Multi-Master System						
Access for NORD diagnosis tool via	diagnostics socket on the device (if available) and via frequency inverter						

## Installation

Installation location	In defined option slot inside the NORDAC device.
Fastening	with screw fastenings

- 1) With NORDAC *LINK*, this assembly must be selected when ordering. The installation is then carried out at the factory. Subsequent installation is not possible.

## Installation steps

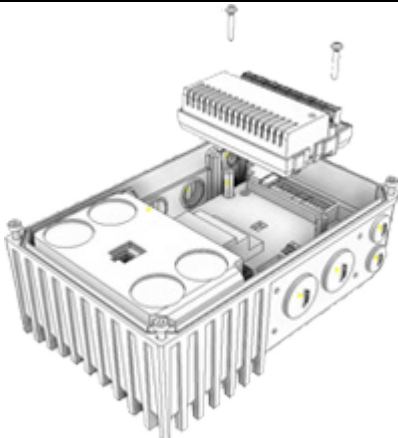
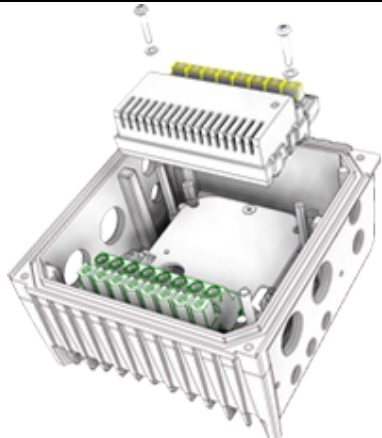
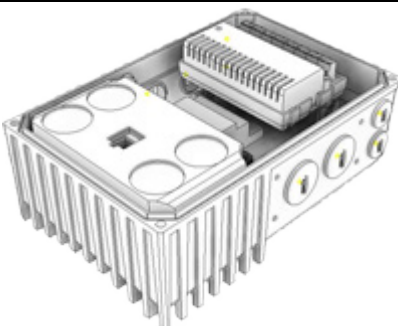
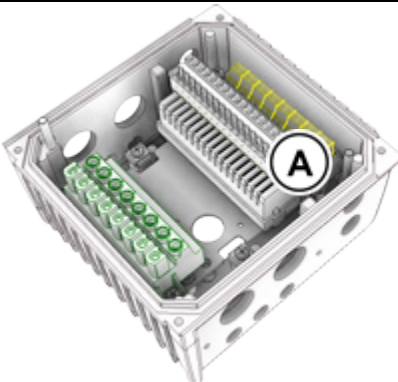
	NORDAC BASE	NORDAC FLEX *)
1.		
2.		

- \*) Before carrying out installation step 1 it may be necessary to remove the control terminal bar ( A ),  
The control terminal bar ( A ) must be fitted after installation step 2.

**Connections**

Connection is via the terminal strip of the bus interface.

Potential	Contact	Designation	Description	
1	System bus level and digital inputs	44	24 V	Supply potential (+24 V ±20%, 90 mA)
		40	GND/0 V	Reference potential (0 V/GND)
		C1	DIN1	Digital input 1 (I/O PROFIBUS DP DIN1)
		C2	DIN2	Digital input 2 (I/O PROFIBUS DP DIN2)
		77	Sys H	System bus data line +
		78	Sys L	System bus data line -
		40	GND/0 V	Reference potential (0 V/GND)
		44	24 V	Supply potential (+24 V ±20%, 90 mA)
2	PROFIBUS DP	82	PBR B	Receive / transmit line, positive
		81	PBR A	Receive / transmit line, negative
		46	GND/0 V Bus	Reference potential for data transmission
		83	RTS	Ready to send
		47	VO/5 V Bus	+5 V bus supply voltage
		82	PRB B	Receive / transmit line, positive
		81	PRB A	Receive / transmit line, negative
		46	GND/0 V Bus	Bus reference potential

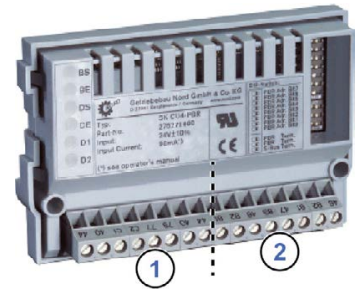

**Connection examples**

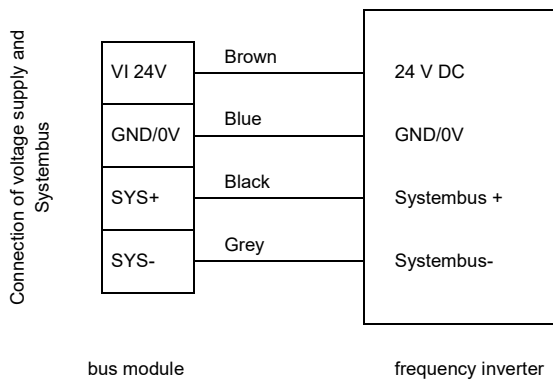

### Configuration

The PROFIBUS address of the bus interface (1) is set via the DIP switches. If the bus interface is the final subscriber on the PROFIBUS field bus or the NORD system bus, the terminating resistors (2) and (3) must be activated.

The DIP switch settings are read in after a “Power On” of the bus interface.

DIP switch	Meaning	Department	Meaning
8	—	Addressing	Bus interface PROFIBUS address
7	Address bit 6		
6	Address bit 5		
5	Address bit 4		
4	Address bit 3		
3	Address bit 2		
2	Address bit 1		
1	Address bit 0		
3	PB Term.	Bus terminal	Terminating resistor for PROFIBUS field bus
2	PB Term.		
1	S-Bus Term.		

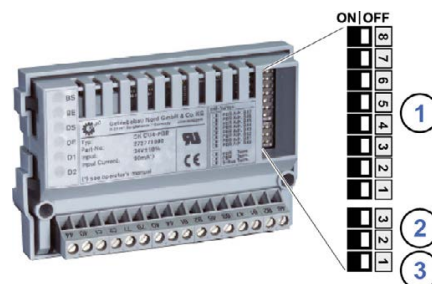

Factory settings DIP switches: **OFF**

#### 1. Addressing (DIP 7 ... 1)

The PROFIBUS is set with binary coding using DIP switches 7...1. Address area "3"..."125".

#### 2. Terminating resistors for PROFIBUS field bus (DIP 2 and 3).

Both DIP switches 2 and 3 must be moved to the “ON” position if the bus interface is the final subscriber on the bus.

#### 3. Termination resistor for NORD system bus (DIP 1)

Set DIP switch 1 to the “ON” position if the bus interface is the final subscriber on the bus.

### Information

#### NORDAC LINK

With the NORDAC LINK, the DIPP switch settings can only be adjusted at the factory. Subsequent adaptation is not possible. The configuration of the module must therefore be defined when ordering.

### LED indicators

The operating statuses of the bus interface are visualised using LED indicators.

No.	Name	Colour	Meaning
1	BR	red/green	PROFIBUS DP Status
	BE	red/green	PROFIBUS DP Error
2	DS	green	Device State
	DE	red	Device Error
3	D1	green	Digital input D1
	D2	green	Digital input D2

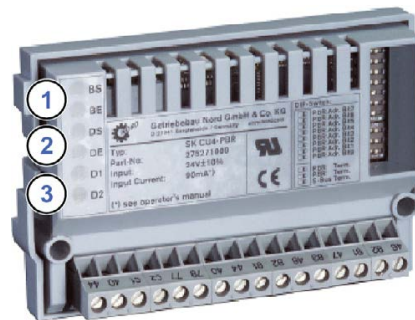

### PROFIBUS DP-specific LED

BR (Bus Ready, PROFIBUS DP Status)	BE (Bus Error, PROFIBUS DP Error)	Meaning
OFF	OFF	Bus interface not ready, no voltage supply or signalling of a system fault via the "DS" and "DE" LEDs.
Steady illumination in green	OFF	Normal operation, cyclic data exchange via PROFIBUS DP.
Flashing green (0.5 s)	OFF	Technology unit has not been configured by the DP master, no cyclic data exchange: <ul style="list-style-type: none"> <li>• PROFIBUS DP cable not connected</li> <li>• Addressing error</li> <li>• PROFIBUS DP-Master in "STOP" state</li> <li>• Defective hardware configuration (e.g. More than 4 connected frequency inverters)</li> </ul>
Steady illumination in red	Steady illumination in red	Communication timeout: Address monitoring time in PROFIBUS DP master expired.
Steady illumination in red	Flashing red (0.5 s)	Timeout during process data reception: The time set in parameter P151 External bus timeout has elapsed without new process data being received.
Flashing red (0.5 s)	Flashing red (0.5 s)	No communication between bus interface and PROFIBUS DP master: <ul style="list-style-type: none"> <li>• Incorrect address range (permitted range "3"..."125")</li> <li>• Bus interface defective</li> </ul>

### NORD-specific LEDs

DS (Device State)	DE (Device Error)	Meaning
		long flashing = 0.5 s on / 1 s off short flashing = 0.25 s on / 1 s off
<b>OFF</b>	<b>OFF</b>	Bus interface not ready, no control voltage
<b>ON</b>	<b>OFF</b>	Bus interface ready, no error, at least one frequency inverter is communicating via the system bus
<b>ON</b>	<b>Short flashing</b>	Bus interface ready, but <ul style="list-style-type: none"> <li>• One or more of the connected frequency inverters has fault status</li> </ul>
<b>Long flashing</b>	<b>OFF</b>	Bus interface ready and at least one other subscriber is connected to the system bus, but <ul style="list-style-type: none"> <li>• No frequency inverter on the system bus (or connection interrupted)</li> <li>• One or more system bus subscriber has an address error</li> <li>• Software incompatible (bus interface software and FI software incompatible - update required)</li> </ul>
<b>Long flashing</b>	<b>Short flashing</b> Flash interval 1 x - 1 s pause	System bus is in status "Bus Warning" <ul style="list-style-type: none"> <li>• Communication on system bus disrupted</li> <li>• No other subscribers present on system bus</li> <li>• Module not inserted correctly or no connection to system bus</li> <li>• Frequency inverter has no supply voltage</li> </ul>
<b>Long flashing</b>	<b>Short flashing</b> Flash interval 2 x - 1 s pause	System bus is in status "Bus Off" <ul style="list-style-type: none"> <li>• The system bus 24 V power supply has been interrupted during operation</li> </ul>
<b>Long flashing</b>	<b>Short flashing</b> Flash interval 3 x - 1 s pause	System bus is in status "Bus Off" <ul style="list-style-type: none"> <li>• The 24 V voltage supply of the system bus is missing</li> </ul>
<b>Long flashing</b>	<b>Short flashing</b> Flash interval 4 x - 1 s pause	Bus interface error <ul style="list-style-type: none"> <li>• See parameter P170</li> </ul>
<b>OFF</b>	<b>Short flashing</b> Flash interval 1 x - 1 s pause	System error, internal program sequence interrupted <ul style="list-style-type: none"> <li>• EMC interference (observe the wiring guidelines!)</li> <li>• Bus interface defective</li> </ul>

### Digital input LEDs

LED (green)	Display	Meaning
<b>D1</b>	<b>ON</b>	"High" potential present at terminal "C1".
	<b>OFF</b>	"Low" potential present at terminal "C1".
<b>D2</b>	<b>ON</b>	"High" potential present at terminal "C2".
	<b>OFF</b>	"Low" potential present at terminal "C2".



### Parameter access and diagnosis

The NORDCON software or optional control units such as the SK PAR-3H ParameterBox provide convenient access to the parameters of the bus interface and allow status information to be read out. In addition, the NORDCON *APP* – in connection with the NORDAC *ACCESS BT* Bluetooth stick – offers a practical way of mobile and wireless maintenance as well as commissioning of NORD frequency inverters.

Access is via the RJ12 diagnostics socket of the frequency inverter. The prerequisite for this is that the bus interface is connected to the frequency inverter via the system bus.

### Further documentation and software ([www.nord.com](http://www.nord.com))

Software	Description
<a href="#">GSD-file</a>	Device characteristics and parameters

Software	Description
<a href="#">NORDCON</a>	Parametrisation and diagnostic software

Document	Description
<a href="#">BU 0000</a>	Description of NORDCON software
<a href="#">BU 0040</a>	Parameter box manual
<a href="#">BU 0180</a>	Frequency inverter manual NORDAC <i>BASE</i>
<a href="#">BU 0200</a>	Frequency inverter manual NORDAC <i>FLEX</i>
<a href="#">BU 0250</a>	Frequency inverter manual NORDAC <i>LINK</i>

Document	Description
<a href="#">BU 2700</a>	PROFIBUS DP bus communication manual
<a href="#">TI 275274505</a>	SK TIE4-M12-SYSM System bus connection expansion exit
<a href="#">TI 275274506</a>	SK TIE4-M12-SYSS System bus connection expansion entrance
<a href="#">TI 275274500</a>	SK TIE4-M12-PRB Ethernet connection expansion PROFIBUS DP input/output