



Complete drive systems from a single source

Technical Manual



DRIVESYSTEMS

Our Solution. Your Success.



Industrial gear units



Geared motors



Frequency inverters and motor starters

- ▶ Headquarters and technology centre in Bargteheide near Hamburg.
- ▶ Innovative drive solutions for more than 100 branches of industry.
- ▶ 7 production locations with cutting-edge technology produce gear units, motors and drive electronics for complete drive systems from a single source
- ▶ NORD has 48 subsidiaries in 36 countries and further sales partners in more than 50 countries. They provide local stocks, assembly centres, technical support and customer service.
- ▶ More than 4,900 employees throughout the world create customised solutions.



Headquarters in Bargteheide



Gear unit production



Inverter production



Motor production



Motor assembly



Production and assembly



Motor production

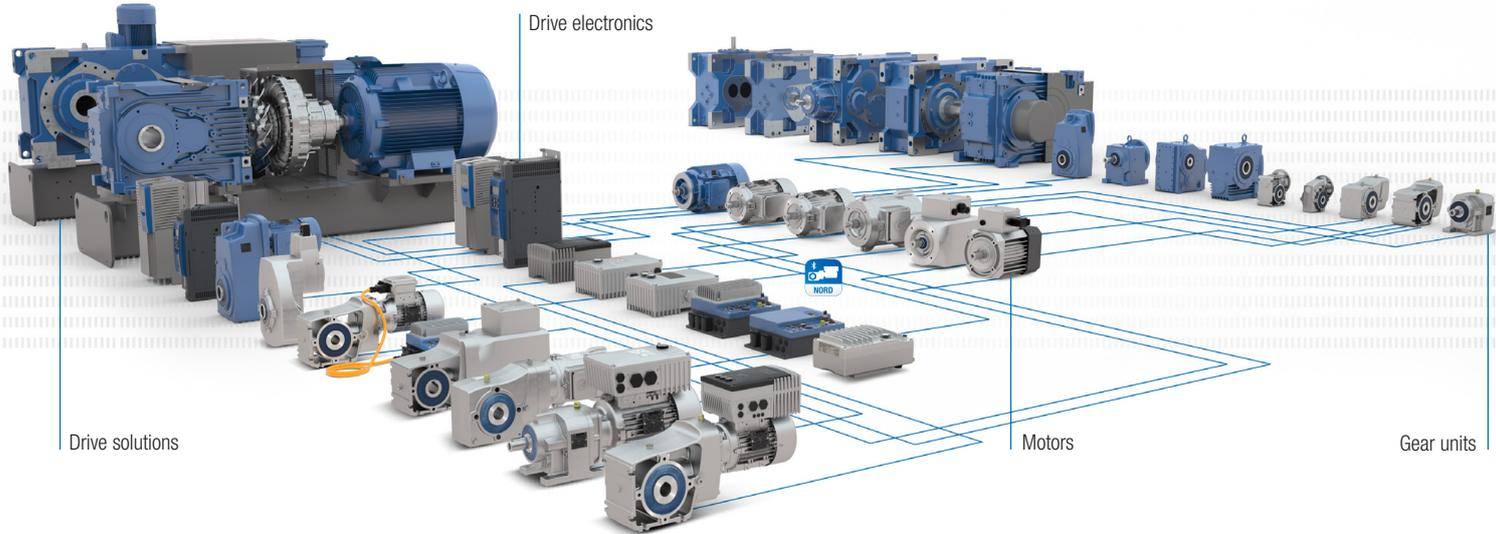

Complete drive solutions from a single source

An optimum and individual drive solution consisting of the three components gear unit, motor and drive electronics can be created using NORD modular products. Each of the variants combine: the highest product quality, short planning and assembly times, high delivery availability, and a good price/performance ratio.

Safe

- ▶ Reliable products
- ▶ Coordinated components
- ▶ Own development and production

Flexible

- ▶ Modular products
- ▶ Scalable functions
- ▶ Large range of drives
- ▶ Complete drive solutions
- ▶ Integrated customer logistics

International

- ▶ Globally networked organisation
- ▶ Local advice, assembly and service

Geared motors

UNICASE helical in-line gear units	10
NORDBLOC.1® helical in-line gear units	12
STANDARD helical gear units	14
UNICASE parallel gear units	16
UNICASE bevel gear units	18
NORDBLOC.1® bevel gear units	20
UNICASE worm gear units	22
UNIVERSAL SI worm gear units	24
UNIVERSAL SMI worm gear units	24
DuoDrive	26
Gear unit options	28

MAXXDRIVE® industrial gear units

MAXXDRIVE® parallel gear units and right-angle gear units	32
Industrial gear units options	38

Motors

Asynchronous motors	42
Smooth motors	46
UNIVERSAL motor	48
Synchronous motors	50
IE5+ motors	52
Explosion-protected motors	55
Motor options	56

Frequency inverters and motor starters

NORDAC <i>PRO</i> SK 500P frequency inverters	60
NORDAC <i>PRO</i> SK 500E frequency inverters	62
NORDAC <i>ON/ ON+</i> SK 300P frequency inverters	64

NORDAC <i>LINK</i> SK 250E frequency inverters	66
NORDAC <i>FLEX</i> SK 200E frequency inverters	68
NORDAC <i>BASE</i> SK 180E frequency inverters	70
NORDAC <i>LINK</i> SK 155 / 175E motor starters	72
NORDAC <i>START</i> SK 135E motor starters	74
NORDCON software	76
NORDAC <i>ACCESS BT/ NORDCON APP</i>	77
PROFIsafe	78
Bus systems and Industrial Ethernet	79
Correct connection technology	80
Condition monitoring for predictive maintenance	82

Technical information

Surface treatment for NORD drive solutions	88
Overview of energy-saving directives for motors	90
Nominal operating modes according to IEC 60034-1	92
Cooling types for NORD motors according to IEC 60034-6 and NEMA	94
International protection codes (IP protection class)	96
Overview of certifications	97

Mounting positions

Mounting positions – Helical gear units	98
Mounting positions – Parallel shaft gear units	99
Mounting positions – Bevel gear units	100
Mounting positions – Worm gear units	101
Mounting positions and cable glands – DuoDrive	102
Mounting positions – MAXXDRIVE® parallel gear units	104
Mounting positions – MAXXDRIVE® right-angle gear units	105
Mounting and terminal box positions – Motors	106
Enquiry process	107

- 1 Industrial gear unit
- 2 DuoDrive
- 3 Worm gear unit
- 4 Bevel gear unit
- 5 Helical gear unit
- 6 Parallel shaft gear unit



UNICASE helical in-line gear unit – The robust all-rounder



- ▶ Foot- or flange-mounted version
- ▶ Long service life, low maintenance
- ▶ Optimum sealing
- ▶ UNICASE™ housing

Sizes: 11
 Power: 0.12–160 kW
 Torque: 10–26,000 Nm
 Ratio: 1.35–14,340.31:1



UNICASE helical in-line gear units

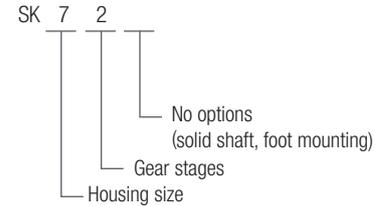

Special nomenclature:

- ▶ SK 33 = Standard series
- ▶ SK 33N = UNICASE series



The main product catalogue for geared motors is G1000. Deviating catalogues/flyers are flagged.

NORDBLOC.1® helical in-line gear unit – The innovative performer (catalogue G1000)



- ▶ Foot- or flange-mounted version
- ▶ Die-cast aluminium housing (cast iron housing for SK 772.1 and higher)
- ▶ UNICASE™ housing
- ▶ Single-stage variant available for applications with high speeds (SK x71.1)
- ▶ Long bearing life
- ▶ High permissible transverse and axial forces
- ▶ Smooth surface
- ▶ Compact design, even with IEC/NEMA adapter
- ▶ Natural corrosion protection, even without painting

Sizes: 13

Power: 0.12–37 kW

Torque: 30–3,300 Nm

Ratio: 1.07–456.77:1



NORDBLOC.1® 1-stage helical in-line gear units

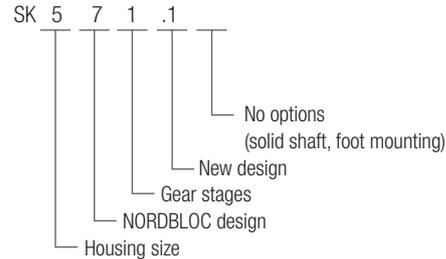

NORDBLOC.1® 2-, 3-stage helical in-line gear units

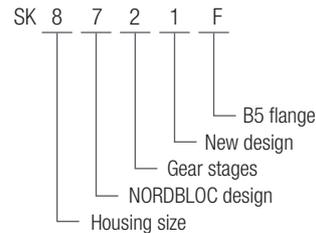

STANDARD helical gear unit – The proven classic (catalogue G2000)



- ▶ Foot- or flange-mounted version
- ▶ Long service life, low maintenance
- ▶ Cast iron housing
- ▶ Reinforced output side (optional)

Sizes: 6

Power: 0.12–7.5 kW

Torque: 50–700 Nm

Ratio: 1.92–488.07:1



STANDARD helical gear units

SK 2 5

Housing size



Special nomenclature:

- ▶ The number of digits corresponds to the number of gear stages; exception SK 0: These gear units have two stages
- ▶ A “5” at the designation end (e.g. SK 225) indicates a reinforced output side (shaft and bearing)

UNICASE parallel gear unit – Slim and powerful



- ▶ Foot, flange or shaft mounted housing
- ▶ Hollow or solid shaft
- ▶ Compact design
- ▶ UNICASE™ housing
- ▶ Durable
- ▶ Low maintenance
- ▶ Quiet running – e.g. for theatre applications
- ▶ NORDBLOC.1® aluminium parallel shaft gear units up to size 4

Sizes: 15
 Power: 0.12–200 kW
 Torque: 110–100,000 Nm
 Ratio: 4.03–15,685.03:1



UNICASE parallel gear units

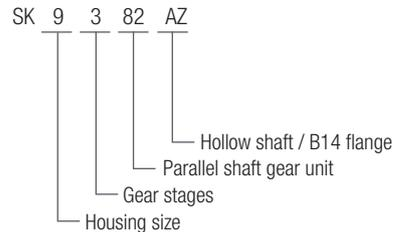

NORDBLOC.1® parallel shaft gear units

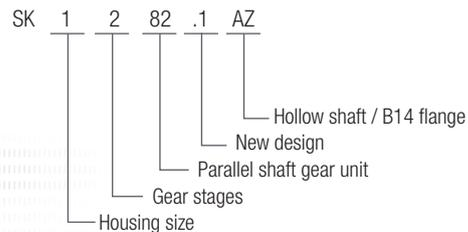

Special nomenclature (NORDBLOC.1®):

- ▶ For SK 0182.1 and SK 0282.1, the number of stages cannot be obtained from the nomenclature (a 2- and 3-stage version is available)

UNICASE bevel gear unit – Powerful and proven (catalogue G1000)



- ▶ Foot, flange or shaft mounted housing
- ▶ Hollow or solid shaft
- ▶ UNICASE™ housing
- ▶ High efficiency
- ▶ Robust design
- ▶ Cast iron housing
- ▶ Various bearing concepts for high axial and radial load capacities
- ▶ Quiet running – e.g. for theatre applications

Sizes: 11

Power: 0.12–200 kW

Torque: 180–50,000 Nm

Ratio: 8.04–13,432.68:1



UNICASE bevel gear units

SK 90 4 2 .1 AZK

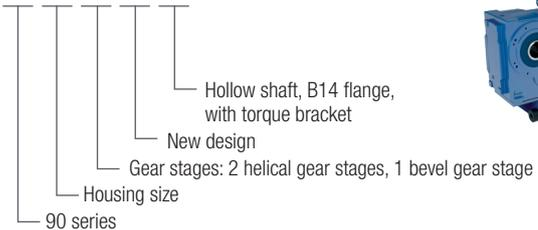

Special nomenclature:

- ▶ A “6” at the end indicates a reinforced version, 3-stage
- ▶ A “7” at the end indicates a reinforced version, 4-stage (each including the bevel gear stage)

NORDBLOC.1® 2-stage bevel gear unit – Power and design



- ▶ Foot, flange or shaft mounted housing
- ▶ Hollow or solid shaft
- ▶ UNICASE™ housing
- ▶ Aluminium housing
- ▶ Wash-down design
- ▶ High power density

Sizes: 6
 Power: 0.12–9.2 kW
 Torque: 50–660 Nm
 Ratio: 3.03–70:1



NORDBLOC.1® 2-stage bevel gear units

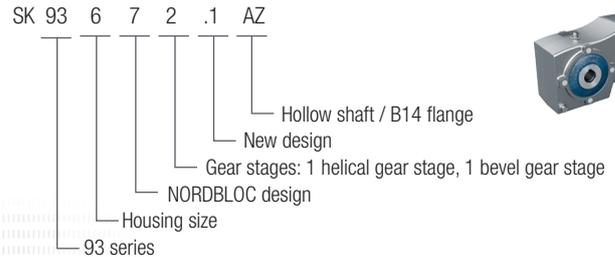
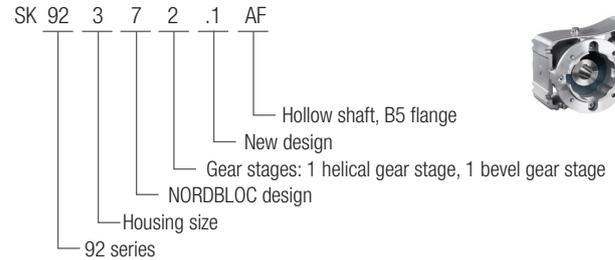

- ▶ SK 920072.1 / SK 930072.1 has the smallest available housing (size 00)

UNICASE worm gear unit – Quiet and powerful



- ▶ Foot, flange or shaft mounted housing
- ▶ Hollow or solid shaft
- ▶ UNICASE™ housing
- ▶ Smooth and quiet running
- ▶ High overload capacity
- ▶ High axial and radial loads
- ▶ Cast iron housing

Sizes: 6

Power: 0.12–15 kW

Torque: 93–3,058 Nm

Ratio: 4.40–7,095.12:1



UNICASE worm gear units

SK 1 2 080

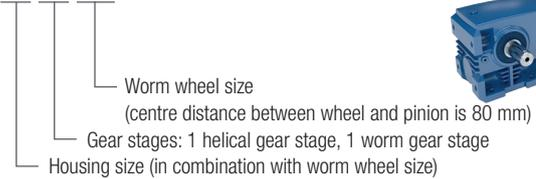

- ▶ The nomenclature can also be used for SK 02040.1

UNIVERSAL SI worm gear unit – Modular and flexible



- ▶ Modular
- ▶ Universal mounting options
- ▶ Life-long lubrication
- ▶ IEC version
- ▶ Aluminium housing

Sizes: 5
 Power: 0.12–4.0 kW
 Torque: 21–427 Nm
 Ratio: 5.00–3,000:1

UNIVERSAL SI worm gear units

SK 1 SI 75/H10

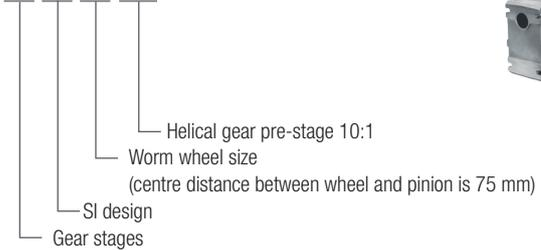

UNIVERSAL SMI worm gear unit – Modular and flexible



- ▶ Smooth surfaces
- ▶ Life-long lubrication
- ▶ IEC version
- ▶ Aluminium housing

Sizes: 5
 Power: 0.12–4.0 kW
 Torque: 21–427 Nm
 Ratio: 5.00–3,000:1

UNIVERSAL SMI worm gear units

SK 1 SMI 31 AZ

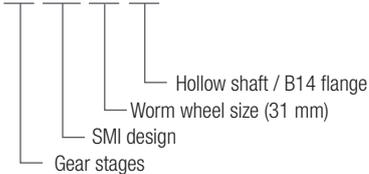

DuoDrive – Integrated gear unit/motor concept



- ▶ High-efficiency IE5+ motor
- ▶ System efficiency up to 92%
- ▶ Results in a significant reduction of the TCO (Total Cost of Ownership) compared to other drive systems
- ▶ High power density
- ▶ Very low noise emission
- ▶ Simple plug-and-play commissioning
- ▶ Hygienic design (wash-down)
- ▶ Design: M1, M4, M5, M6

Sizes: 2

Power: 0.35–3.0 kW

Torque: 26–247 Nm

Ratio: 3.24–18.1:1

DuoDrive

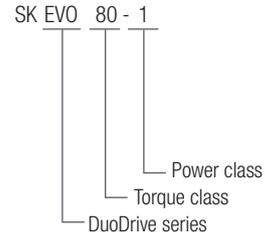

Product catalogue:
DuoDrive, G5010

Gear unit options

Designation	Meaning
A	Hollow shaft
AF	Hollow shaft, B5 flange
AX	Hollow shaft, foot mounting
AXF	Hollow shaft, foot mounting, B5 flange
AZ	Hollow shaft, B14 flange
AZD	Hollow shaft, B14 flange with torque arm
AZK	Hollow shaft, B14 flange with torque bracket
B	Fixing element for hollow shaft
D	Torque arm
EA	Splined hollow shaft DIN 5480
G	Rubber buffer for torque arm
H	Covering cap as contact guard
IEC	Adapter for fitting B5 IEC standard motors
NEMA	NEMA C-flange motor adapter
LX	Solid shaft – both sides, foot mounting
MK	Motor bracket
R	Integrated back stop
RLS	Back stop in W adapter
S	Hollow shaft with shrink disc

Designation	Meaning
SEK	Servo adapter with clamp coupling
SEP	Servo adapter with key coupling
V	Solid shaft
VF	Solid shaft, B5 flange
VL	Reinforced bearing
VL2	Agitator version
VL3	Agitator version with "Drywell"
VX	Solid shaft, foot mounting
VXF	Solid shaft, foot mounting, B5 flange
VXZ	Solid shaft, foot mounting, B14 flange
VZ	Solid shaft, B14 flange
W	Drive cylinder with free input shaft
XF	Foot mounting, B5 flange
XZ	Foot mounting, B14 flange

- ▶ Not all options are available for all gear units
- ▶ Detailed descriptions and diagrams can be found in the relevant catalogues
- ▶ More options can be found in the cited catalogues or on request (e.g. belt drive)
- ▶ Multiple options are stated in a row, e.g. SK 2282 S H G (hollow shaft with shrink disc, cover, rubber buffer)

- 1 MAXXDRIVE® XT right-angle gear unit
- 2 MAXXDRIVE® XJ right-angle gear unit
- 3 MAXXDRIVE® right-angle gear unit
- 4 MAXXDRIVE® parallel gear unit
- 5 MAXXDRIVE® XD parallel gear unit

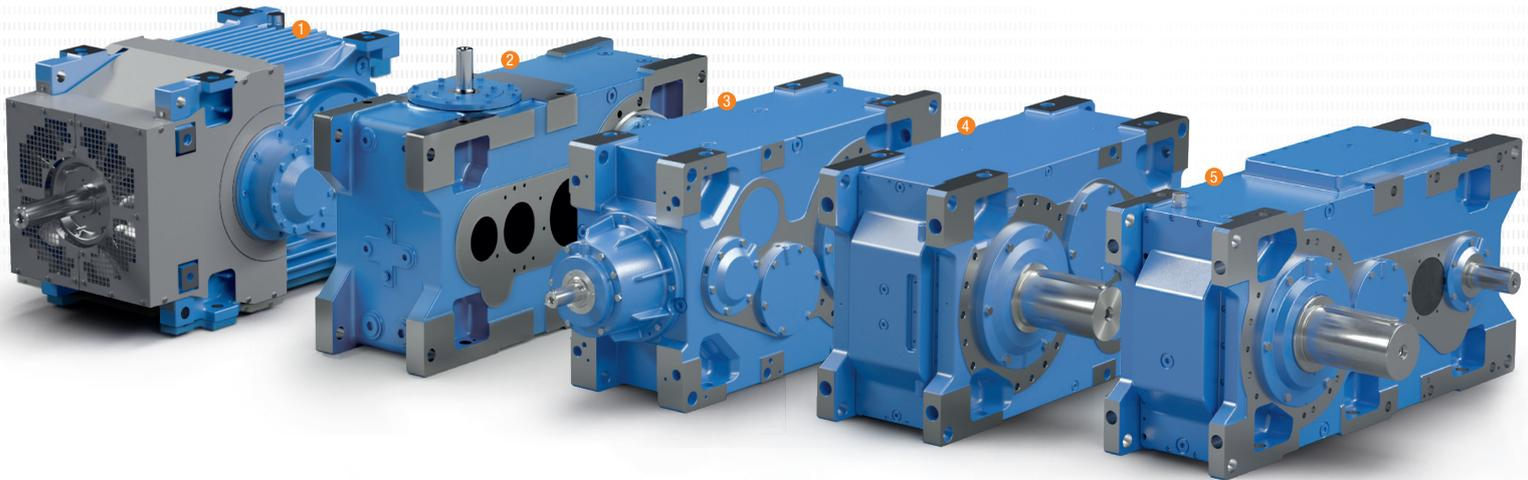

MAXXDRIVE® industrial gear units

- ▶ UNICASE™ housing, no joints subject to torque
- ▶ All bearing points and sealing surfaces are machined in one setting
- ▶ High-precision axis alignment for quiet running
- ▶ Long service life, low maintenance
- ▶ MAXXDRIVE® parallel gear units and MAXXDRIVE® right-angle gear units

MAXXDRIVE® parallel gear unit (catalogue G1050)



- ▶ Universal gear unit
- ▶ 2- and 3-stage
- ▶ Multiple mounting and cooling options
- ▶ Adapted bearing options for high radial and axial load capacity
- ▶ Compact design
- ▶ All mounting positions

Sizes: 11

Power: 1.5–6,000 kW

Torque: 15,000–282,000 Nm

Ratio: 5.54–30,000:1

MAXXDRIVE® right-angle gear unit (catalogue G1050)



- ▶ Universal gear unit
- ▶ 3- and 4-stage
- ▶ Multiple mounting and cooling options
- ▶ Adapted bearing options for high radial and axial load capacity
- ▶ Compact design
- ▶ All mounting positions

Sizes: 11

Power: 1.5–2,150 kW

Torque: 15,000–260,000 Nm

Ratio: 12.61–30,000:1

MAXXDRIVE® XT right-angle gear unit (T160-0011)



- ▶ 2-stage
- ▶ Thermally optimised gear unit
- ▶ Integrated high-performance axial fan
- ▶ High powers with low ratio
- ▶ Optimised for horizontal mounting position
- ▶ Ideal for applications such as belt conveyors or bucket elevators

Sizes: 7

Power: 22–2,100 kW

Torque: 15,000–75,000 Nm

Ratio: 6.14–22.91:1

MAXXDRIVE® XD parallel gear unit (flyer S1056)



- ▶ 3- and 4-stage
- ▶ Housing with increased centre distance
- ▶ Inspection cover
- ▶ Housing optimised for downward radial loads
- ▶ Ideal for lifting gear

Sizes: 5

Power: 1.5–925 kW

Torque: 15,000–112,000 Nm

Ratio: 22.4–355:1

MAXXDRIVE® XJ right-angle gear unit



- ▶ 3-stage
- ▶ New input shaft position “J-mount”
- ▶ Horizontal and vertical mounting positions
- ▶ Modular
- ▶ Flexible

Sizes: 5

Power: 5.5–1,275 kW

Torque: 15,000–107,000 Nm

Ratio: 12.5–100:1



Product catalogue:
MAXXDRIVE® industrial gear units,
G1050

MAXXDRIVE® industrial gear units

SK 11 2 17 AS H MS FAN 355LP/4

Motor designation
 Additional options (FAN, CC, ...)
 Motor attachments (IEC, NEMA, MS, ...)
 Additional options (D, H, B, ...)
 Shaft and mounting options (A, V, L, ...)
 Type designation

MAXXDRIVE® parallel gear unit

MAXXDRIVE® right-angle gear unit

	07	21 (XD)	07	17 (XT)	18 (XJ)
2-stage	2	–	–	2	–
3-stage	3	3	4	–	4
4-stage	–	4	5	–	–

Sizes (5–15)

MAXXDRIVE® drive systems



- ▶ Complete drive systems consisting of gear unit, motor and drive electronics
- ▶ Wide selection of other components, e.g. couplings or brakes
- ▶ Standardised solutions for swing bases and base frames, e.g. for belt conveyors or bucket elevators
- ▶ Systems tailored to applications, e.g. agitators, lifting gear or extruders
- ▶ Individually adaptable

Industrial gear unit options

Designation	Meaning
A	Hollow output shaft with key groove
AS	Hollow output shaft for shrink disc
B	Fastening set for hollow shaft
CC	Internal water cooler
CS1	External oil-water cooler
CS2	External oil-air cooler
D	Torque arm
DRY	"True Drywell" agitator version with standard bearing
EA	Splined hollow output shaft, DIN 5480
ED	Elastic torque arm
EV	Splined solid output shaft, DIN 5480
EW	Splined solid input shaft, DIN 5480
F	Flat output flange (B14 with threaded holes)
FAN	Fan or electrical fan
FK	High output flange (B5 with through holes)
F1	Drive flange (SK..207 / SK..307)
H/H66	Cover (contact guard) / IP66 cover
IEC	Adapter for B5 mounting, IEC standard motors
L	Double solid output shaft
LC	Pressurised oil lubrication (bearings)
LCX	Pressurised oil lubrication with "Drywell" (bearings and gearwheels)
MC	Motor bracket
MO	Measuring devices and sensors
MF	Motor frame (options: see MF..)
MFB	Base frame with brake
MS	Motor swing base (options: see MS...)
MSB	Motor swing base with brake
MFK	Motor frame with elastic coupling
MFT	Motor frame with turbo coupling

Designation	Meaning
MSK	Motor swing base with elastic coupling
MSKB	Motor swing base with elastic coupling and brake
MST	Motor swing base with turbo coupling
MFTB	Motor frame with turbo coupling and brake
MSTB	Motor swing base with turbo coupling and brake
MT	Motor mount
NEMA	Adapter for fitting B5 NEMA C flange, standard motors
OT	Oil reservoir tank
OH	Oil heater
R*	Back stop
V	Solid output shaft
VL2	Agitator version
VL3	Agitator version with "Drywell"
VL4	Agitator version with "True Drywell"
VL5	Extruder flange
VL6	Agitator version with "True Drywell" without flange
WX	Auxiliary drive
WG	First-stage gear unit
W1, W2*, W3*	W1/2/3 – number of solid input shafts, W3 – for 407 and 507 types
–	Brakes
–	Couplings
–	Paintings
–	Endurance Package

* R, W2, W3 – not available for all ratios

- ▶ Not all options/combinations are available for all gear units
- ▶ Detailed descriptions and diagrams can be found in the relevant catalogues
- ▶ More options can be found in the cited catalogues or on request
- ▶ Multiple options are stated in a row, e.g. SK 11217 AS H ED (hollow output shaft with shrink disc, cover and elastic torque arm)

- 1 UNIVERSAL motor
- 2 IE5+ synchronous motors
- 3 Synchronous and asynchronous motors
- 4 Smooth motors

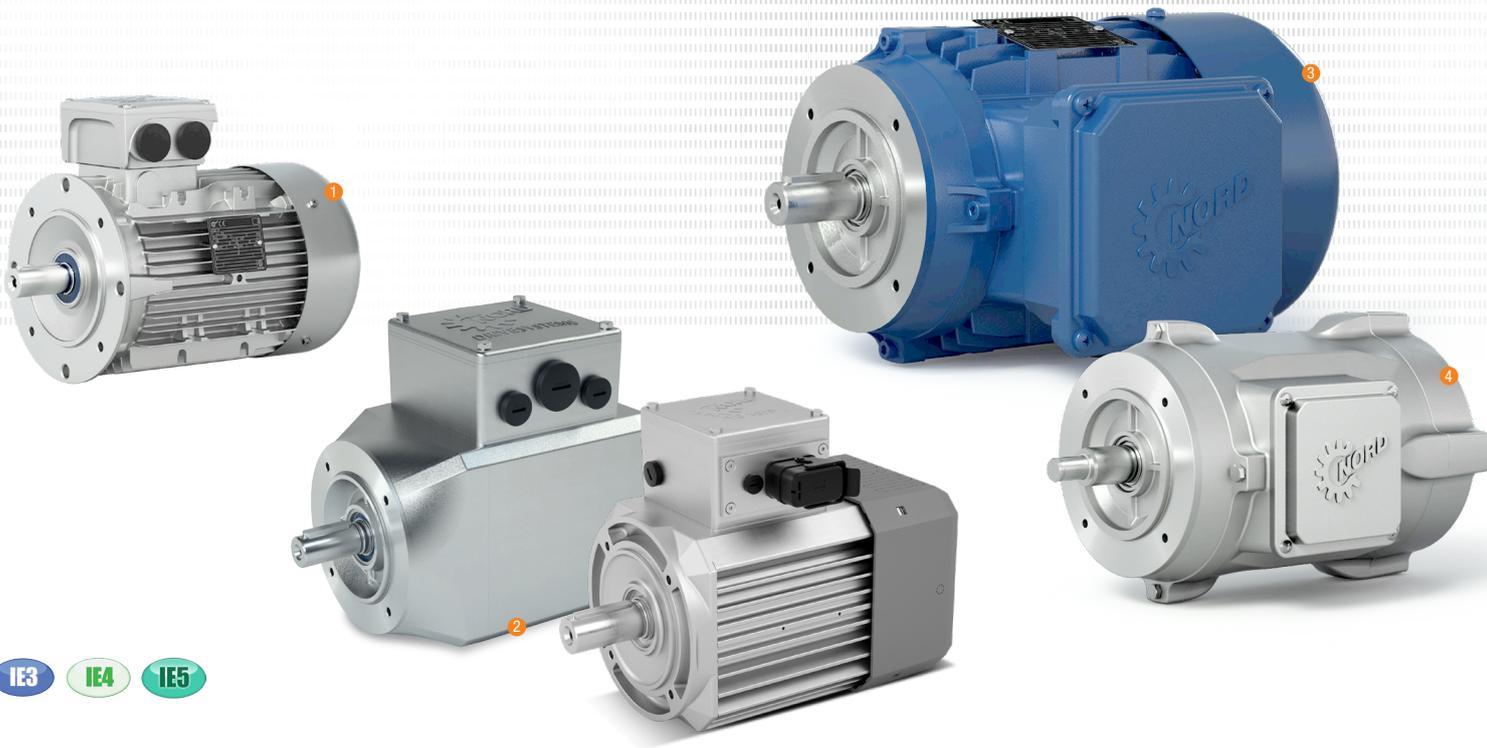

Standard asynchronous motors



- ▶ Comply with international regulations and directives
- ▶ Extensive options possible
- ▶ ISO F used according to B (ISO H as an option)
- ▶ Suitable for inverter operation
- ▶ High overload reserves

Sizes: 63–225
Power: 0.12–55 kW
Number of poles: 2, 4, 6, 8
Protection class: IP55, optionally IP66
Efficiency class: IE1, IE3

Asynchronous switchable pole motors



- ▶ ISO F used according to B

Sizes: 63–160
Power: 0.12–17 kW
Number of poles: 4-2, 8-2, 8-4
(more poles on request)
Protection class: IP55, optionally IP66
Efficiency class: IE1

Single-phase asynchronous motors (T160-0015)



- ▶ ISO F used according to B
- ▶ With operating and starting capacitor

Sizes: 63–90
Power: 0.12–1.5 kW
Number of poles: 4
Protection class: IP55, optionally IP66
Efficiency class: IE1, IE2



Product catalogue:
Asynchronous motors, M7000

IEC asynchronous motors

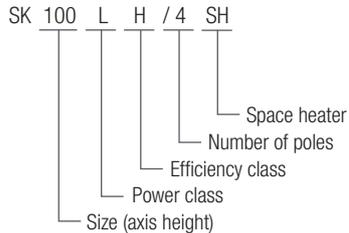

- ▶ X or W in the nomenclature designates a smaller size. For example, SK 250 WP is a 55 kW motor in a size 225 housing

NEMA C-FACE asynchronous motors

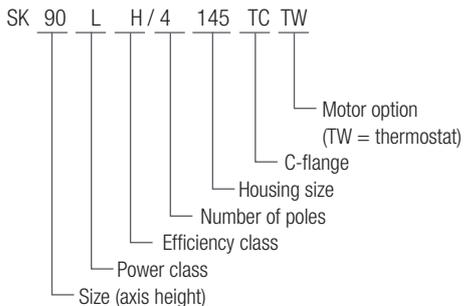

Asynchronous switchable pole motors

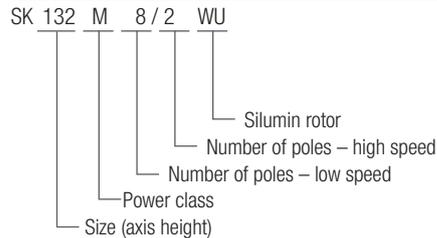

Single-phase asynchronous motors

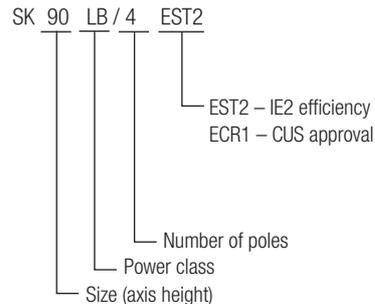

Asynchronous smooth motors



- ▶ ISO F
- ▶ Suitable for inverter operation
- ▶ Wash-down design
- ▶ Smooth surfaces, especially suitable for food industry applications

Sizes: 71–100

Power: 0.12–2.2 kW

Number of poles: 4

Protection class: IP66, optionally IP69K
(in combination with the gear unit)

Efficiency class: IE3

Asynchronous smooth motors

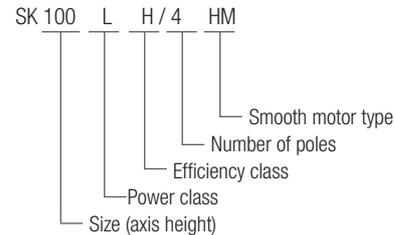

- ▶ For non-ventilated smooth motors, the efficiency code letter is H or P for Premium Efficiency (IE3)

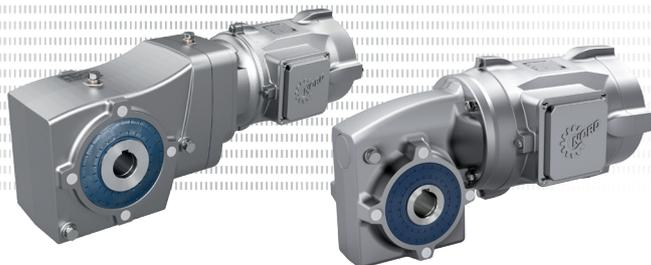

Product catalogue:
NORD motors, M7010

UNIVERSAL motor



International certification

- ▶ CE
- ▶ UL standard 1004
- ▶ CSA
- ▶ CCC
- ▶ EAC
- ▶ ISI
- ▶ UA
- ▶ UKCA
- ▶ NOM

International energy standards

- ▶ IEC 60034-30
- ▶ EISA 2007
- ▶ EER 2010
- ▶ CEL/GB 18613
- ▶ MEPS AS/NZ 1359.5

Dual-Mode: 50 Hz and 60 Hz
 Four different operating points

Sizes: 63–225
 Power: 0.12–45 kW
 Number of poles: 4
 Protection class: IP55, optionally IP66
 Efficiency class: IE3 / Premium

3~Mot. SK 90 SP/4 CUS TF BRE20

V	D/Y	Hz	A	kW	hp	cosφ	r/min	Nom.EFF	
220/380		50	4,25/2,45	1,1	1,5	0,81	1420	84,9	
230/400		50	4,12/2,38	1,1	1,5	0,78	1430	85,3	IE3
240/415		50	4,19/2,42	1,1	1,5	0,76	1435	85,5	
265/460		60	3,64/2,14	1,1	1,5	0,76	1740	86,9	IE3

Tamb 40 °C

20,7 kg

IEC/EN 60034 (H) SF 1,15 NEMA CODE L
 Th. CI155(F) IP55 TEFC DP
 三相异步电动机 Usable at 440V Y 60Hz
 Over Temp Prot-2 Class F Usable at 480V Y 60Hz
 Brake 20 Nm 230 VAC 205 VDC
 201912345-1200 930 12345678 2020

NOM-016-ENER-2016

Getriebebau NORD GmbH & Co. KG, 22939 Bargteheide / GERMANY www.nord.com

Sample name plate for a UNIVERSAL motor
 UA and UKCA are tagged separately on the motor.



Flyer:
 UNIVERSAL motor, DS1005

Standard synchronous motors (TI60-0001 and TI60-0004)



- ▶ ISO B
- ▶ Only suitable for inverter operation
- ▶ Open- or closed-loop operation with NORD frequency inverters
- ▶ High overload reserves

Sizes: 80–100

Power: 1.1–5.5 kW

Number of poles: 4

Protection class: IP55, optionally IP66

Efficiency class: IE4

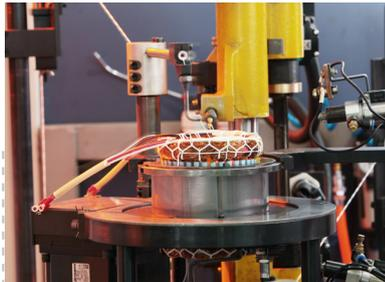

Standard synchronous motors

SK 100 T 2 / 4 Δ

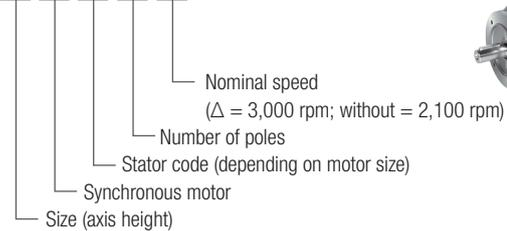

IE5+ synchronous motors



- ▶ Maximum operational efficiency with IE5 technology
- ▶ Reduced Total Cost of Ownership (TCO) and fast Return on Investment (ROI)
- ▶ Reduced number of variants through constant torque over a wide speed range
- ▶ Motor can be operated worldwide
- ▶ Flexible motor mounting: Direct mounting, IEC, NEMA
- ▶ Unventilated motors in smooth housing for wash-down applications
- ▶ Optional motor-integrated encoder
- ▶ Optional integrated mechanical brake

Sizes: 71, 90

Power: Unventilated (TENV) 0.35–2.2 kW
 Ventilated (TEFC) 0.5–3.7 kW

Number of poles: 8

Torque: 1.6–14.7 Nm

Protection class: IP55, optionally IP66 or IP69K (in combination with the gear unit)

Efficiency class: At times, IE5 is significantly exceeded

IE5+ synchronous motors

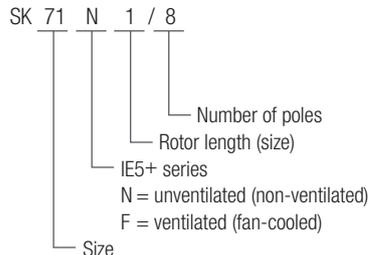

Product catalogue:
 IE5+ synchronous motors, M5000

IE5+ synchronous motors



IE5

The IE5+ synchronous motor is characterised by its very high efficiency. Compared to asynchronous motors, high energy savings are possible, especially in the partial load and partial speed range.* This minimises the customer's TCO.

* Sample efficiency:
Load 50% / Speed 37.5%

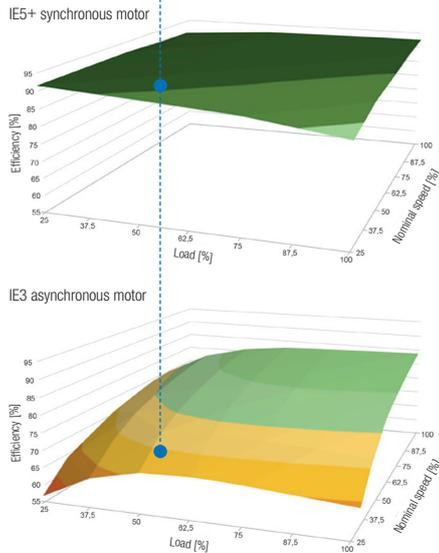

Explosion-protected motors, dust atmospheres (catalogue G2122)



- ▶ Zone 21, device category 2D, Ex tb 125 °C
- ▶ Zone 22, device category 3D, Ex tb 125 °C
- ▶ Direct and IEC mounting

Sizes: 2D: 63–180 / 3D: 63–250
Power: 2D: 0.12–22 kW / 3D: 0.12–55 kW
Number of poles: 4
Protection class: IP55, optionally IP66
Efficiency class: IE3

Explosion-protected motors, gas atmospheres (catalogue G2122)



- ▶ Zone 1, device category 2G, Ex T3
- ▶ Zone 2, device category 3G, Ex T3
- ▶ Direct and IEC mounting

Sizes: 63–180
Power: 0.12–17.5 kW
Number of poles: 4
Protection class: IP55, optionally IP66
Efficiency class: IE3



- ▶ Motors according to IEC Ex, EAC Ex, CCC Ex and NEC 500 (HazLoc) are also available, see catalogue G2122
- ▶ Further information on European Explosions Protection is given in manual part no. 6091601
- ▶ Other motor sizes and ignition protection types on request

Motor options

Designation	Meaning
BRE +	Brake / brake torque + suboptions
DBR +	Double brake + suboptions
RG *	Rust-protected version
SR *	Dust- and rust-protected version
IR *	Current relay
FHL *	Lockable manual brake release
HL	Manual brake release
MIK	Micro switch
AS55 *	Outdoor installation
BRB	Space heater / brake
NRB1/2	Noise-reduced brake
ERD	External ground terminal
TF	Temperature sensor, PTC resistor
TW	Thermostat, bimetallic
SH	Space heater
WU	Silumin rotor
Z	Additional centrifugal mass, cast-iron fan
WE	Second shaft end
HR	Handwheel
RD	Drip cover
RDT	Drip cover, textile fan cover
RDD	Double fan cover
AS66	Outdoor installation
OL	Without fan
OL/H	Without fan, without cover

Designation	Meaning
KB	Closed condensation drain hole
MS	Motor plug connection
EKK	One-piece terminal box
KKV	Encapsulated terminal box
FEU	Insulation against moisture
TRO	Insulation for tropical protection
VIK	Regulation – Verband der Industriellen Energie- und Kraftwirtschaft (German association of industrial energy consumers)
F	External fan
RLS	Back stop
MG	Magnetic incremental encoder
SL	Sensor bearing
IG	Incremental encoder
IG.P	Incremental encoder with plug
IG.K	Incremental encoder with terminal box
AG	Absolute encoder

* not for DBR



- ▶ Not all options are available for all motors
- ▶ Detailed descriptions and diagrams can be found in the relevant catalogues
- ▶ More options on request (e.g. 2xTF or PT100)

Electronic drive technology

- 1 NORDAC START
- 2 NORDAC BASE
- 3 NORDAC LINK FDS
- 4 NORDAC FLEX
- 5 NORDAC PRO
- 6 NORDAC ON

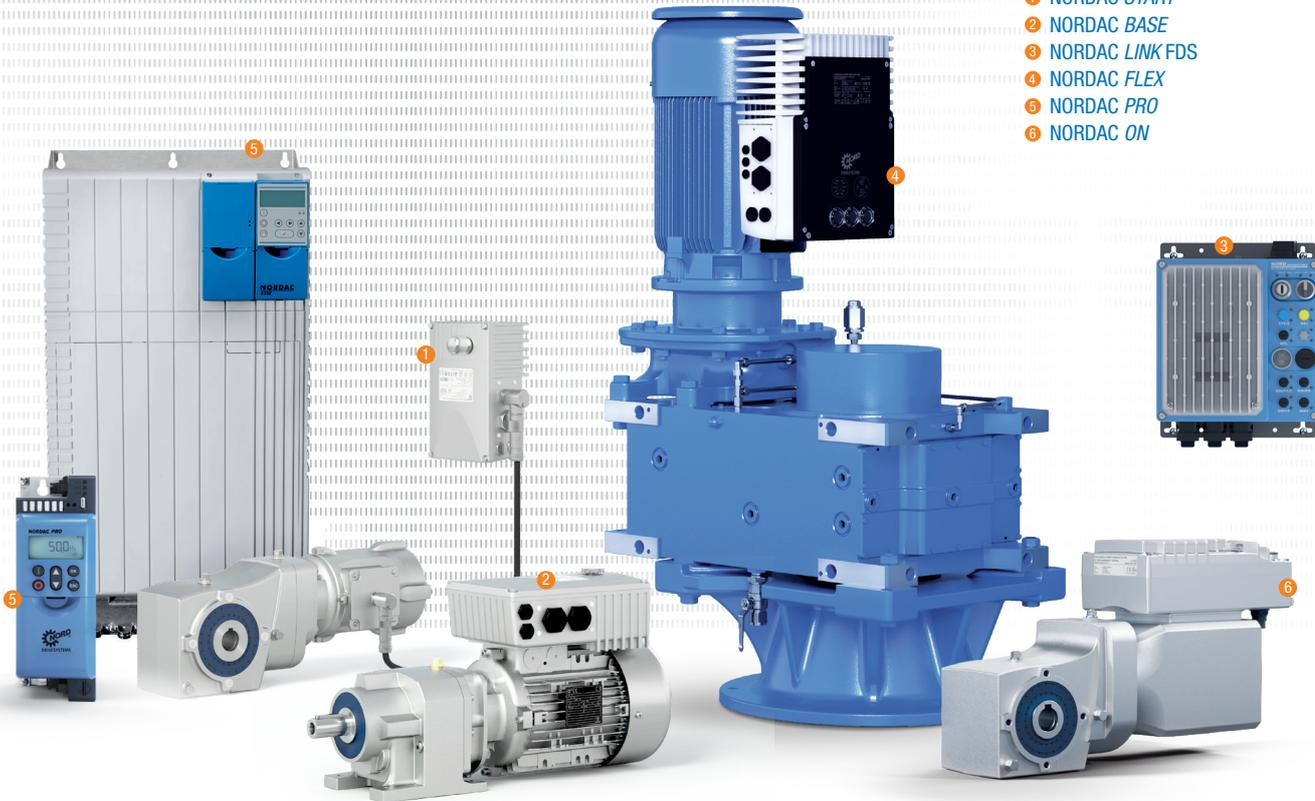

NORDAC PRO SK 500P – One product, all advantages



Control cabinet frequency inverter

- ▶ Universal professional drive in various basic versions, can be modularly extended
- ▶ Precise current vector control with high overload reserves up to 200% for operating asynchronous and synchronous motors
- ▶ POSICON – integrated positioning mode
- ▶ Universal interface for real-time Ethernet Profinet, EtherCAT, EtherNet/IP and POWERLINK
- ▶ CANopen as standard equipment
- ▶ DS402 drive profile for CANopen, EtherCAT and POWERLINK
- ▶ Integrated PLC function for drive-related functions, even in the basic device
- ▶ TTL encoder interface and optional universal encoder interface
- ▶ Optional: Safe stop with “Safe Torque Off” (STO) and “Safe Stop 1” (SS1-t) according to EN 61800-5-2
- ▶ MicroSD card
- ▶ USB interface for connection to NORDCON may also be used without voltage supply
- ▶ Compact and slim design, can be directly installed without spacing
- ▶ In sizes 1 and 2, all terminal connections are pluggable, including the power connections for mains and motor

Sizes: 5

Voltage: 1~ 200–240 V, 3~ 380–480 V

Power: 0.25–22 kW

NORDAC PRO SK 500P

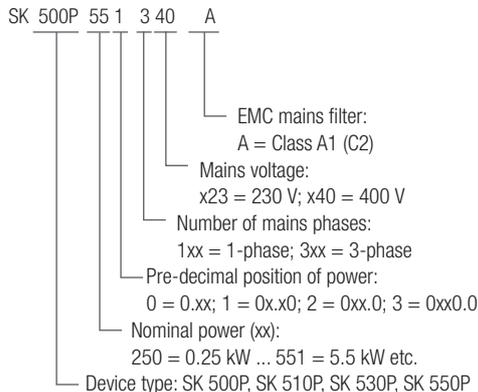

Product catalogue:
Electronic drive technology, E3000

NORDAC PRO SK 500E – High functionality, full power



Control cabinet frequency inverter

- ▶ Maximum functionality
- ▶ Sensorless current vector control (ISD control)
- ▶ Multi-encoder interface
- ▶ Integrated PLC for drive-related functions, SK 520E and higher
- ▶ Optional: POSICON positioning, SK 530E and higher
- ▶ Optional: Safe stop with “Safe Torque Off” (STO) and “Safe Stop 1” (SS1) according to EN 61800-5-2 (for SK 510E and SK 530E)
- ▶ ASM and PMSM motor operation
- ▶ Energy-saving function
- ▶ High overload reserves (200%) across all power ratings up to 160 kW
- ▶ Many field bus- and Industrial Ethernet-based bus systems
- ▶ Optional: CANopen integrated in SK 511E and higher
- ▶ Integrated class C1 line filter
- ▶ Alternative cooling systems, e.g. “Cold Plate”
- ▶ IP20 control cabinet installation

Sizes: 11

Voltage: 1~ 110–120 V, 1~ 200–240 V, 3~ 200–240 V, 3~ 380–480 V

Power: 0.25–160 kW

NORDAC PRO SK 500E

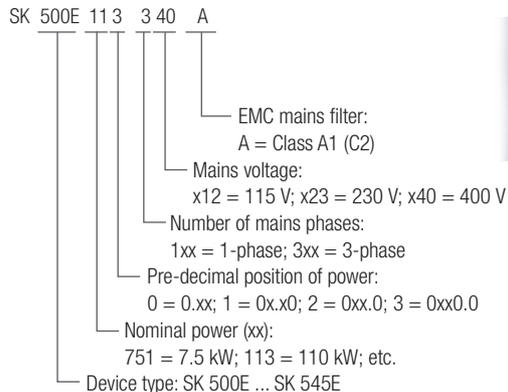

NORDAC ON/ON+ SK 300P – Strong focus, optimum function



Decentralised frequency inverter

The frequency inverter particularly serves the special requirements of horizontal conveyor technology. NORDAC ON has been developed for IE3 drives while NORDAC ON+ has been optimised for the combination with the IE5+ synchronous motor. It is characterised by an integrated Ethernet interface and full pluggability as well as a very compact design. An economic plug-and-play solution for IIoT environments

- ▶ 4 digital inputs, 2 digital outputs
- ▶ Functional safety: STO, SS1
- ▶ Integrated Ethernet interface can be configured for each parameter
- ▶ Firmware update via Ethernet
- ▶ Encoder interfaces: RS485
- ▶ Simple installation and maintenance due to full pluggability
- ▶ 4 parameter sets, which can be switched directly online
- ▶ 4-quadrant operation with integrated brake chopper
- ▶ V/f control, current vector control in open-loop and closed-loop mode
- ▶ High precision control and high overload characteristics for synchronous and asynchronous motors
- ▶ PLC functionality for drive-related functions
- ▶ POSICON – integrated positioning mode
- ▶ Ambient temperature: -30 °C ... +40 °C (S1)
-30 °C ... +50 °C (S3, 70% ED)

NORDAC ON/ON+ SK 300P



- NORDAC ON** ▶ With optimised IE3 motor
- NORDAC ON+** ▶ With the latest IE5+ motor
- NORDAC ON PURE** ▶ Inverter for the food sector with IE5+ smooth motor

Sizes: 3

Power: 0.37–3.7 kW (*PURE* up to 1.5 kW)

Mains voltage: 3~ 400 V

Supply voltage: 24 V DC external

- ▶ NORDAC ON: typ. overload capacity: 150% for 60 s, 200% for 5 s, 250% for 1 s
- ▶ NORDAC ON+: typ. overload capacity: 150% for 60 s, 200% for 5 s, up to 300% for 1 s
- ▶ NORDAC ON protection class: IP55
- ▶ NORDAC ON+ protection class: IP55/IP66

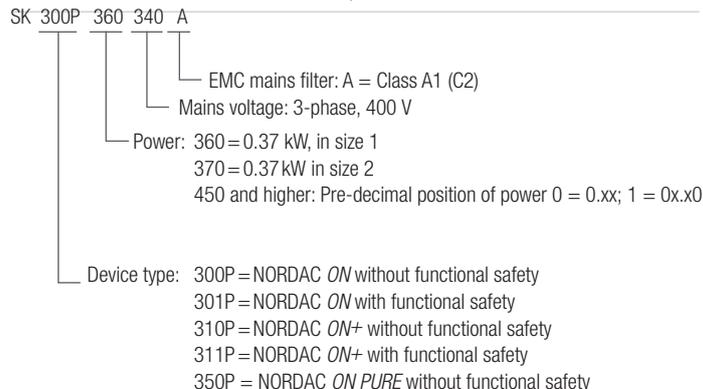

NORDAC LINK SK 250E FDS – Quick installation, easy maintenance



Frequency inverter

- ▶ Simple installation and maintenance due to full pluggability
- ▶ Optional maintenance switch and pluggable EEPROM for easy servicing
- ▶ Free configuration
- ▶ Field installation close to the geared motor thanks to high protection class IP55/IP65
- ▶ Operation of asynchronous and synchronous motors
- ▶ High overload up to 200% and 4-quadrant operation thanks to optional braking resistor solutions
- ▶ Many field bus- and Industrial Ethernet-based bus systems as well as ASi
- ▶ Local control via optional key/manual switches, buttons and potentiometers
- ▶ Safe stop with “Safe Torque Off” (STO) and “Safe Stop 1” (SS1) according to EN 61800-5-2 as well as PROFIsafe with functional safety functions, e.g. Safe Limit Speed
- ▶ POSICON – integrated positioning mode

Sizes: 3

Voltage: 3~ 380–500 V

Power: 0.37–7.5 kW

NORDAC LINK SK 250E FDS

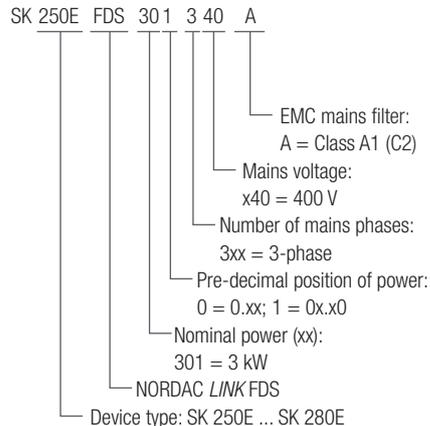

- ▶ FDS = Field Distribution System

NORDAC FLEX SK 200E – Greater flexibility, lower costs



Decentralised frequency inverter

- ▶ Sensorless current vector control (ISD control)
- ▶ Integrated PLC for drive-related functions
- ▶ Integrated POSICON positioning control
- ▶ Safe stop with “Safe Torque Off” (STO) and “Safe Stop 1” (SS1) according to EN 61800-5-2 as well as PROFIsafe with functional safety functions, e.g. Safe Limit Speed
- ▶ ASM and PMSM motor operation
- ▶ Energy-saving function
- ▶ Motor or wall mounting
- ▶ IP55 (optionally IP66)
- ▶ AS-Interface integrated in SK 22xE and SK 23xE
- ▶ Many field bus- and Industrial Ethernet-based bus systems
- ▶ Comprehensive selection of plug connectors for control cable and power connections
- ▶ ATEX zone 22, category 3D (sizes 1–3)
- ▶ POSICON – integrated positioning mode

Sizes: 4

Voltage: 1~ 110–120 V, 1~ 200–240 V, 3~ 200–240 V,
3~ 380–500 V

Power: 0.25–22 kW

NORDAC FLEX SK 200E

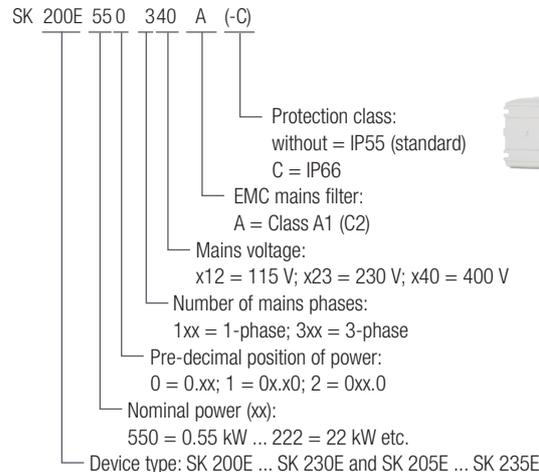

NORDAC BASE SK 180E – Compact drive, key drive functions



Decentralised frequency inverter

- ▶ Sensorless current vector control (ISD control)
- ▶ Integrated PLC for drive-related functions
- ▶ Operation on standard RCD possible, leakage current < 16 mA
- ▶ AS-Interface integrated in SK 190E
- ▶ Energy-saving function
- ▶ Motor or wall mounting
- ▶ IP55 (optionally IP66 or IP69K)
- ▶ Integrated line filter
- ▶ 2 analogue inputs, 3 digital inputs, 2 digital outputs
- ▶ Temperature sensor input (TF+ /TF-)
- ▶ RS485 (system bus/RS232 interface)
- ▶ ATEX zone 22, category 3D

Sizes: 2

Voltage: 1~ 110–120 V, 1~ 200–240 V, 3~ 200–240 V,
3~ 380–500 V

Power: 0.25–2.2 kW

NORDAC BASE SK 180E

SK 180E 75 0 340 B (-C) XXX

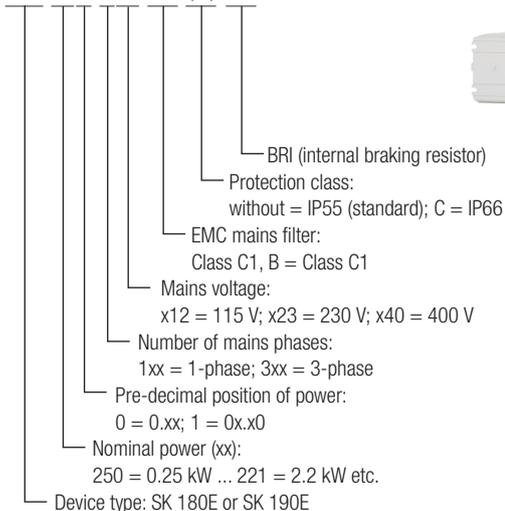

NORDAC START SK 135E – Compact drive, wear-free starting



Decentralised motor starter

- ▶ Motor starter with soft start and reversing function
- ▶ Integrated brake rectifier to control a brake (BRE)
- ▶ Integrated PROFIBUS or AS-Interface
- ▶ Wall or motor mounting
- ▶ IP55 (optionally IP66 and IP69K)
- ▶ Integrated line filter
- ▶ 2 digital inputs, 2 digital outputs
- ▶ Temperature sensor input (TF+/TF-)
- ▶ RS232 interface
- ▶ ATEX zone 22, category 3D
- ▶ Electronic starter switches without wear
- ▶ Reduced mechanical wear due to reduced starting torque

Sizes: 2

Voltage: 3~ 200–500 V

Power: 0.25–7.5 kW

NORDAC START SK 135E

SK 135E 301 340 B ASI C (-NSD) for IP69K

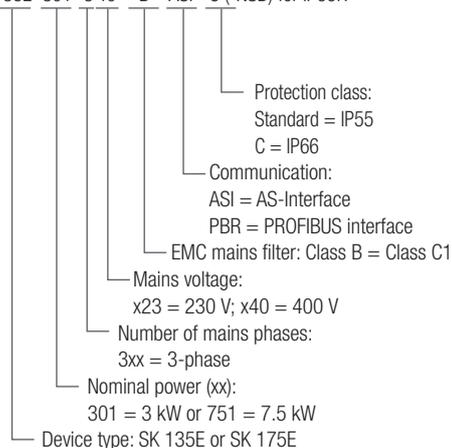

Mains-powered electric motors are very widespread. They require low installation and commissioning effort.

On the other hand, disadvantages include the high power consumption for the starting torque (up to 7 times the nominal motor current), excessive mechanical loads on the gear unit and the system, as well as the frequently uncontrolled starting and stopping behaviour. Here, electronic starters are a simple and very economical **solution**. However, NORD devices are far more than simple current limiting “starters” for electric motors.

NORDAC LINK SK 155E/175E FDS – Quick installation, wear-free starting



Motor starter

- ▶ All I/O, bus interfaces and power connections pluggable for easy commissioning and maintenance
- ▶ Extensive options, e.g. key switch/maintenance switch
- ▶ Integrated PLC for drive-related functions
- ▶ Wear-free fully electronic starting with reversing function
- ▶ Functional compatibility with modular NORDAC *START*
- ▶ Protection class IP65
- ▶ Easy commissioning
- ▶ AS-Interface or PROFIBUS can be used
- ▶ Field installation
- ▶ Parameterisable on site

Sizes: 1
 Voltage: 3~ 380–500 V
 Power: 0.12–3 kW

NORDAC LINK SK 155E/175E FDS

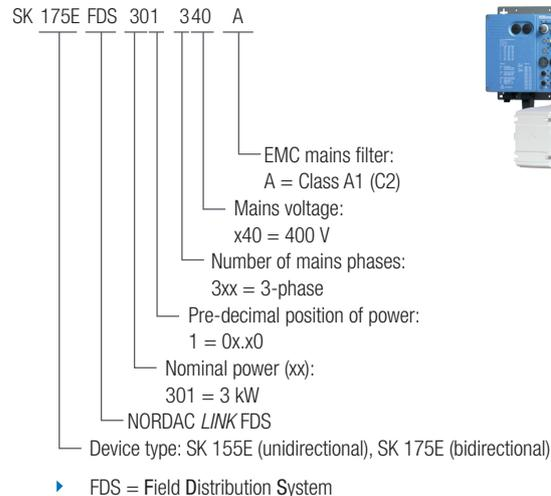

NORDCON software



NORDCON is the free operating software for control, parameterisation and diagnostics of all NORD frequency inverters and motor starters.

▶ Control

Analogous to a SimpleBox (optional control and parameterisation device), a virtual control element enables the display of operating values and the parameterisation and control of a connected frequency inverter or motor starter.



▶ Parameterisation

By means of a convenient overview, the user can view and adjust every available parameter. With the corresponding printing option, parameter lists are generated in printed form either completely or only with the values, which deviate from the factory settings. The final data sets can be saved on a PC/laptop and archived for later use or sent by e-mail.



▶ Diagnostics

The oscilloscope function of the NORDCON software is an extremely helpful instrument for the optimum adjustment of drive systems. By means of line graphs, all drive characteristics (current, torque, etc.) can be recorded and analysed. Based on the results, fine tuning to ideal parameter settings of the relevant drive is possible.



▶ Programming the PLC

A PLC editor is available for creating, editing and managing a PLC program. The PLC programs can also be tested (debugged) with this editor and communicated to the frequency inverter. The programming languages "Structured Text" and "Instruction List" according to IEC 61131-3 are supported.

Mobile commissioning and service solution

NORDAC ACCESS BT



With the NORDAC *ACCESS BT* removable Bluetooth stick, you can now establish 1:1 connections to your mobile terminal device. Together with the free NORDCON *APP*, which of course is available for both Android and iOS, you virtually have a smart tool in your pockets, with which you can conveniently access your device. The available functions (display, parameterisation and oscilloscoping of operating values) are familiar from the Windows-based NORDCON software, but are now a little smarter.

- ▶ Stand-alone parameter memory
- ▶ Bluetooth interface for inverter and NORDCON *APP*
- ▶ Data transfer to PC via USB
- ▶ Can be plugged/disconnected during operation

NORDCON APP



- ▶ Dashboard-based visualisation for drive monitoring and fault diagnosis
- ▶ Parameterisation with help function and rapid access to parameters
- ▶ Individually configurable oscilloscope function for drive analysis
- ▶ Backup and recovery function for simple handling of drive parameters

PROFIsafe



Safe Motion PROFIsafe via Profinet with module SK TU4-PNS



Safety functions for drives according to IEC 61800-5-2

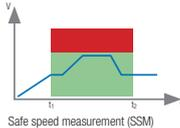
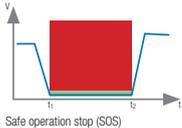
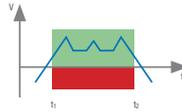
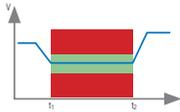
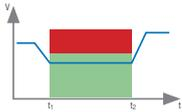

- ▶ PL_e (performance level) Cat. 4 acc. to ISO 13849-1
- ▶ SIL 3 (safety integrity level) acc. to IEC 62061

+ User-defined safe I/O configuration

- ▶ Easy implementation of safe responses available for NORDAC *FLEX* and NORDAC *LINK*
- ▶ Comprehensive safety for reliable operation of systems and machinery
- ▶ Functional safety with one single network cable
- ▶ Minimised wiring effort
- ▶ Global availability of fail-safe machine data

Bus systems and Industrial Ethernet

Bus systems/Industrial Ethernet

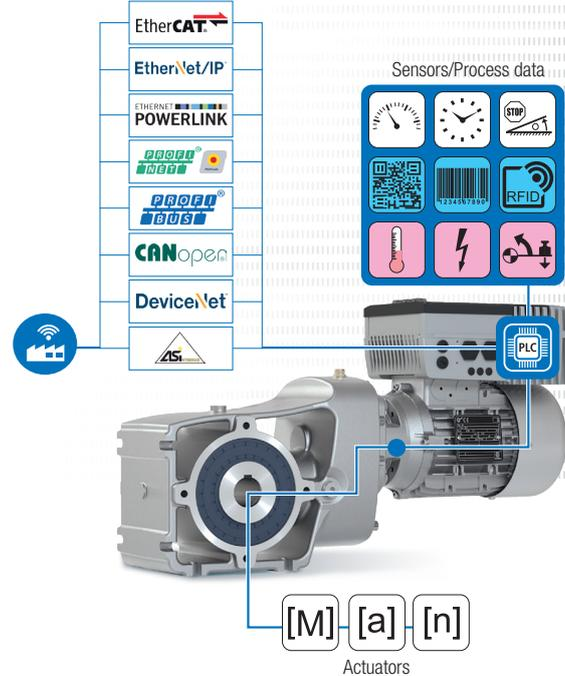

Correct connection technology – pre-assembled



NORD DRIVESYSTEMS supplies an extensive range of connection and control cables.

- ▶ Depending on the version, connecting cables include power connection cables (mains or motor) and, if necessary, cables for PTC resistors as well as 24 V DC control voltage
- ▶ Control cables are exclusively used for transmitting control signals (encoder signals, bus signals, I/O signals)

Connection and control cables are supplied pre-assembled. They are available in various lengths and can be optionally provided with open ends or plug connectors.

- ▶ Cables for motor and frequency inverter connection
- ▶ Mains connection and daisy chain cables
- ▶ Signal and brake resistor cables

Correct connection technology – pre-assembled

SC H4G2.5 HQ8SMM H10E1SMF 1.5 UL

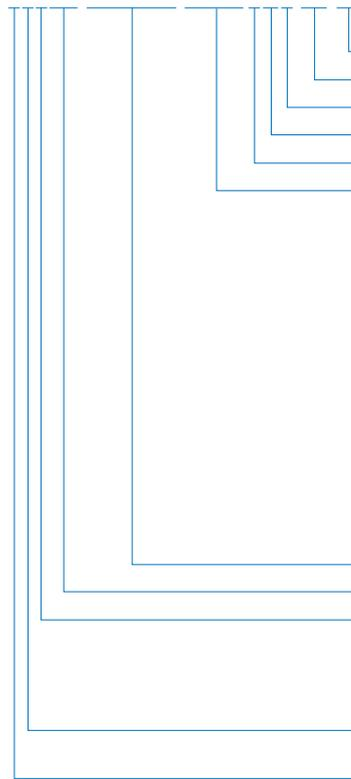

UL marking is included if required

The length is given in metres

M = plug (male) F = socket (female)

Plug material P = plastic, M = metal

Plug design S = straight, A = angled

Cable end

- HQ8 = HAN Q8/0 plug
- HQ4 = HAN Q4 plug (w/o = without)
- HQ42 = HAN Q4/2 plug (24 V DC)
- H10E1 = HAN 10E plug with 1 bracket
- H10E2 = HAN 10E plug with 2 brackets
- NQ16 = Plug, round, 6-pole
- M8-A4 = M8 plug, A-coded / 4-pole
- ...
- OE = Open end
- OE25A4 = Open end with M25 screw connection, max. A4 fork terminal
- OECC = Open end, crimp contact
- OEFI = Open end, insulated electric wire ferrules
- OEF = Open end, electric wire ferrules
- OECLA4 = Open end, without screw connection, max. A4 fork terminal
- ...

Second cable end accordingly

Max. cable cross-section in mm

Type of cable

- S = Shielded with protective conductor
- Y = Shielded without protective conductor
- G = Unshielded with protective conductor
- X = Unshielded without protective conductor

Number of flexible strands with max. cross section

Cable type P = power, S = signal, H = hybrid

Condition monitoring for predictive maintenance

With condition monitoring, drive and status data is recorded periodically or continuously in order to optimise operational safety and efficiency of machinery and systems.

Condition monitoring can provide important information for predictive maintenance. The objective is to maintain machinery and systems proactively, to reduce downtimes and to increase the entire system efficiency.

The INDUSTRIAL INTERNET of THINGS (IIoT) focuses on the application of the internet in industrial processes and procedures. IIoT aims to increase operational efficiency, reduce costs and speed up processes. Sensors and sensor data play a central role to provide the basis for condition monitoring and predictive maintenance.

- ▶ Condition monitoring solutions for predictive maintenance systems integrated into the frequency inverter
- ▶ System is IIoT / INDUSTRY 4.0 READY!
- ▶ Available for decentralised and control cabinet solutions



Flyer:
Condition monitoring for
predictive maintenance, S9091

Temperature curve of the oil in the gear unit

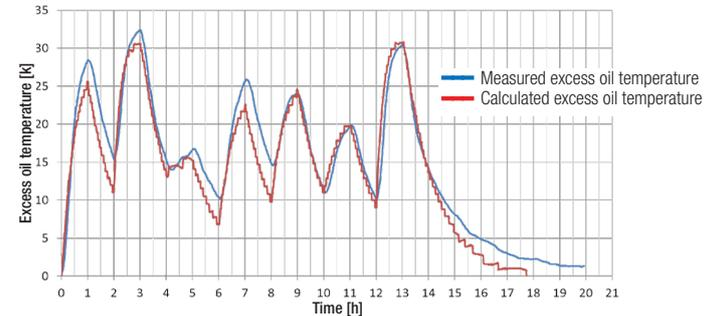

Sensors

- ▶ Virtual sensors – the internal PLC can calculate information such as the optimum oil change time
- ▶ Interface for digital/analogue sensors

Communication interfaces

- ▶ Threshold values or general status information can be communicated to the outside (via common Industrial Ethernet dialects)

Integrated PLC

- ▶ Local pre-processing of data in the integrated PLC
- ▶ Pre-processing of threshold values

Condition monitoring for predictive maintenance (flyer S9091)



System vibration sensor

- ▶ NORD qualified sensors
- ▶ Customer-specific sensors can be connected (analogue/digital)



Temperature sensor

- ▶ PT1000-based motor temperature sensor
- ▶ Ambient or system temperature



Oil change

- ▶ Determination of the optimum oil change time based on the virtual oil temperature
- ▶ The algorithm is executed in the integrated PLC



Drive parameters

- ▶ Read-out of the drive system parameters
- ▶ Basis for virtual sensors



Integrated PLC

- ▶ Pre-processing of drive-specific parameters and drive-related sensors
- ▶ Evaluation of drive conditions



Signal beacon

- ▶ Local display of drive operating conditions
- ▶ Scalable display



Local data management (IPC)

- ▶ Preparation of drive data for drive and system analysis
- ▶ Condition monitoring



Local dashboard

- ▶ Display of drive and system data



Higher-level PLC

- ▶ Processing of condition monitoring information by the customer
- ▶ Combination of condition monitoring information with process data

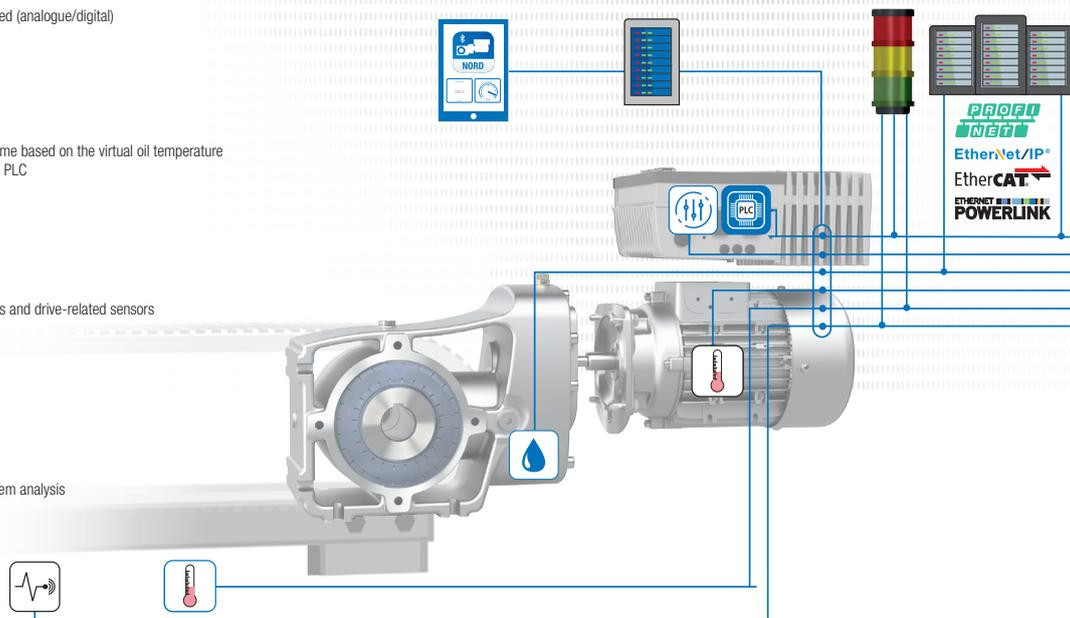

- ▶ Surface protection for NORD drive solutions
- ▶ Energy-saving directives for motors
- ▶ Nominal operating modes
- ▶ International protection codes
- ▶ Certifications
- ▶ Mounting positions

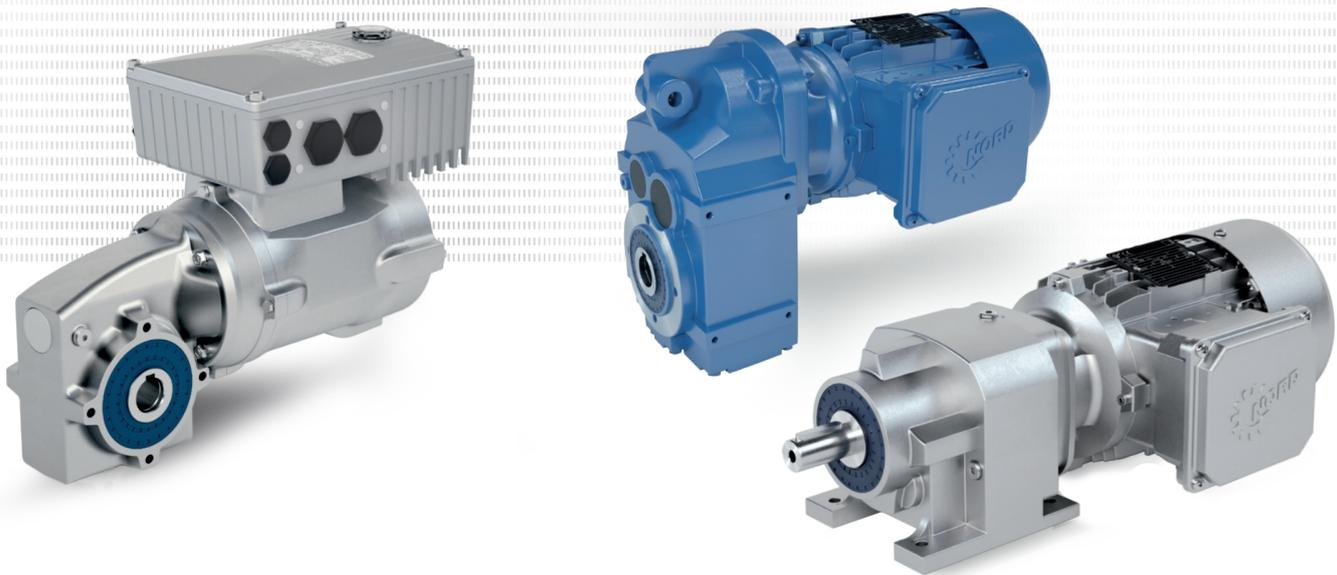

Surface protection for NORD drive solutions

Coating/Application range	Class**	Structure	Coating thickness*
Basic Basic+ Indoor installation Formerly F2	C2	A T D	50–90 µm
NORD Severe Duty 2 NORD Severe Duty 2+ Indoor installation and protected outdoor installation (e.g. in open, unheated halls) Formerly F3.0	C2	A T P D	110–150 µm
NORD Severe Duty 3 NORD Severe Duty 3+ Outdoor installation, urban and industrial atmospheres with low contamination Formerly F3.1	C3	A (2x) T P D	160–200 µm
NORD Severe Chem Duty 3 Normal chemical loads Formerly F3.4	C3	T E D	100–140 µm
NORD Severe Food Duty 3 NORD Severe Food Duty 3+ Areas for food packaging Formerly F3.5	C3	A T E D	100–140 µm

Coating/Application range	Class**	Structure	Coating thickness*
NORD Severe Duty 4 NORD Severe Duty 4+ Outdoor installation, urban and industrial atmospheres with moderate contamination Formerly F3.2	C4	A (2x) T (2x) P D	220–260 µm
NORD Severe Duty 5 NORD Severe Duty 5+ Outdoor installation, urban and industrial atmospheres with high contamination Formerly F3.3	C5	A (2x) T (2x) E D	200–240 µm
A	Optional antimicrobial top coat (+ variants), coating thickness + 25 µm		
Z	Filling of contour recesses and crevices with polyurethane-based sealant possible with NSD2, NSD3 and NSD4, included in NSD5		
T	2-component polyurethane top coat		
E	2-component-EP zinc phosphate primer		
P	2-component polyurethane primer		
D	Single-component dip primer (for cast iron housings only)		

**Comparable to DIN EN ISO 12944-2 classification of ambient conditions
*Protocol of coating thickness following ISO 19840 available on request

Overview of energy-saving directives for motors

Region	Efficiency standard / specification	Minimum energy efficiency
 Europe	IEC 60034-30	IE3: 0.75 to < 75 kW IE4: 75 to 200 kW
 United Kingdom	IEC 60034-30	IE3: 0.75 to < 75 kW IE4: 75 to 200 kW
 Switzerland	IEC 60034-30	IE3: 0.75 to < 75 kW IE4: 75 to 200 kW
 Turkey	IEC 60034-30	IE3: 0.75 to < 75 kW IE4: 75 to 200 kW
 Egypt	ES 2623-3	IE3
 USA	NEMA MG-1	Premium Efficiency (IE3)
 Canada	CSA C390-10	Premium Efficiency (IE3)
 China	GB 18613-2012; GB 25958-2010	Grade 3 (IE3)
 Brazil	INMETRO NBR 17094-1	Alto Rendimento Plus (IE3)
 Mexico	NOM-016-ENER-2016	Premium Efficiency (IE3)
 Colombia	Resolución no 1012 : 2015	IE3
 Chile	PE N° 7/01/2; IEC 60034-30-1	IE2

Region	Efficiency standard / specification	Minimum energy efficiency
 Ecuador	NTE INEN 2498 : 2009	IE2
 Australia New Zealand	AS/NZS 1359.5 : 2004	IE2
 India	IS 12615: 2018	IE2
 South Korea	KS C IEC 60034	IE3
 Singapore	S602 : 2018	IE3
 Taiwan	IEC 60034-2-1	IE3
 Japan	JIS C 4034-30 : 2011	IE3
 Saudi Arabia	IEC 60034-30 : 2013	IE3
 Eurasian Economic Union	IEC 60034-2-1	IE3 from 1 September 2025 (scheduled)
 Ukraine	IEC 60034-2-1	IE3



Please note that standards and directives are subject to constant change and that this excerpt is just a rough overview. More information can be found on our homepage.
Efficiency directives for electric motors

Nominal operating modes according to IEC 60034-1

Power increase in short-time duty and intermittent duty:
 In short-time duty (S2) and intermittent duty (S3), electric motors can be subjected to greater loads than in continuous duty (S1). (See motor catalogue M7000)

- ▶ With operating mode S2, the operating time is indicated in minutes based on 60 minutes. "S2 – 15" means that the motor may be operated continuously for 15 minutes per hour.
- ▶ With S3, S4, S5 and S6, a percentage is indicated: "S3 40%": 40% operating time related to 10 minutes



Product catalogue:
 M7000 asynchronous motors

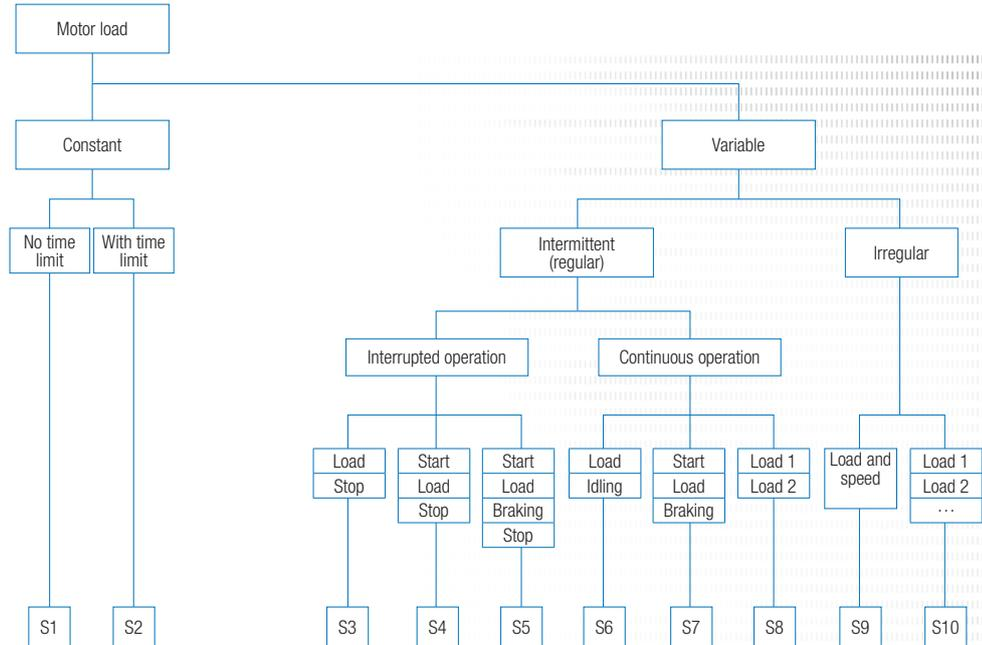

Cooling types for NORD motors according to IEC 60034-6 and NEMA

IC411 "TEFC" – Fully encapsulated, self-ventilated motor



- ▶ Ribbed or smooth housing
- ▶ Fan on the motor shaft
- ▶ Fan speed and air volume directly depend on the motor speed
- ▶ Air flow also cools driven components, e.g. gear units
- ▶ Most common cooling method for electric motors

NORD products

- ▶ All NORD motors with ribbed housing

IC410 "TENV" – Fully encapsulated, unventilated motor



- ▶ Ribbed or smooth housing
- ▶ No fan
- ▶ Quiet running – Fan noise is eliminated
- ▶ Reduced length with option OL/H
- ▶ No ambient air turbulences
- ▶ Widely used in the hygiene sector and in theatre engineering and stage technology

NORD products

- ▶ NORD option OL or OL/H
- ▶ Asynchronous smooth motors
- ▶ Unventilated IE5+ synchronous motor

IC416 "TEBC" or "TEFV" – Fully encapsulated, externally ventilated motor



- ▶ Ribbed or smooth housing
- ▶ External fan directly mounted on the motor
- ▶ Fan speed and air volume are independent of the motor speed
- ▶ External fan is an independent unit with separate voltage supply
- ▶ Air flow also cools driven components, e.g. gear units
- ▶ Preferentially used during inverter operation, if full motor torque is required with low speed

NORD products

- ▶ NORD option F

International protection codes (IP protection class) (IEC 60529)

Digit 1	Protection against foreign bodies	Digit 2	Protection against moisture
0	No protection	0	No protection
1	Protected against solid foreign bodies with diameter above 50 mm	1	Protection against dripping water
2	Protected against solid foreign bodies with diameter above 12.5 mm	2	Protection against dripping water if the housing is inclined by up to 15°
3	Protected against solid foreign bodies with diameter above 2.5 mm	3	Protection against falling spray water up to 60° from the vertical line
4	Protected against solid foreign bodies with diameter above 1.0 mm	4	Protection against splash water from all sides
5	Protected against damaging amounts of dust	5	Protection against water jets (nozzle) from any angle
6	Dust-proof	6	Protection against strong water jets
		7	Protection against temporary immersion
		8	Protection against permanent immersion
		9K (according to ISO 20653)	Protection against water for high-pressure cleaning/steam jet cleaning, specifically for road vehicles

- ▶ If one of the numbers is not stated, this is indicated by an "X", e.g.: IP4X (protection against foreign bodies > 1.0 mm, no details of protection against moisture)
- ▶ For IPX7, the immersion depth and the immersion time must also be stated
- ▶ Up to IPX6, the lower protection classes are included

Overview of certifications

Region	Label	Abbreviation	Meaning
 Europe		CE	Conformité Européenne, European conformity
 United Kingdom		UKCA	UK Conformity Assessed
 China		CCC	China Compulsory Certification
 USA		UL	Underwriters Laboratories
 Canada		CSA	Canadian Standards Association
 Eurasian Economic Union		EAC	Eurasian Conformity
 India		BIS	Bureau of Indian Standards
 Ukraine		UA	UkrSEPRO
 Mexico		NOM	Normas Oficiales Mexicanas
 Brazil		ABNT	Associação Brasileira de Normas Técnicas
 South Korea		KC	Korea Certification
 Australia		RCM	Regulatory Compliance Mark
 Morocco		VOC	Verification of Conformity

The NORD UNIVERSAL motor has many of the certifications mentioned and can therefore be used flexibly.

Mounting positions – Helical gear units

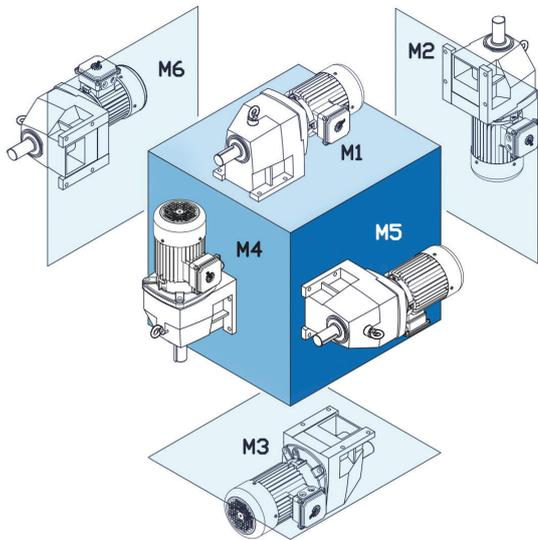

Mounting positions – Parallel shaft gear units

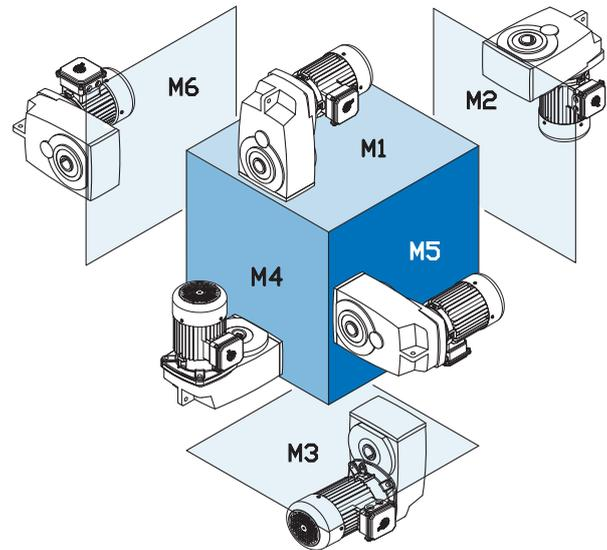

Mounting positions – Bevel gear units

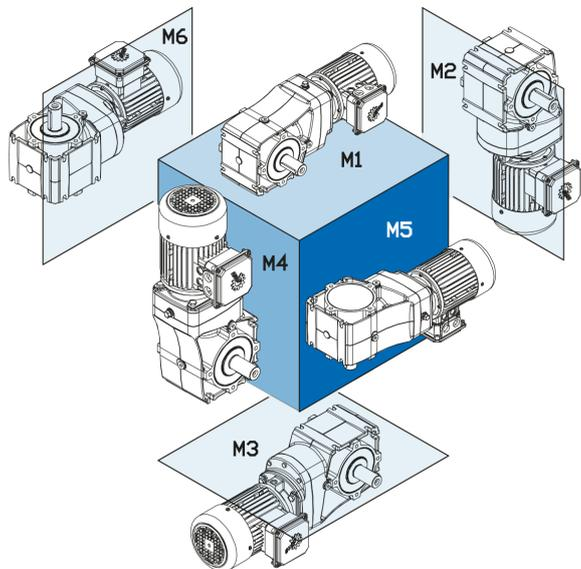

Mounting positions – Worm gear units

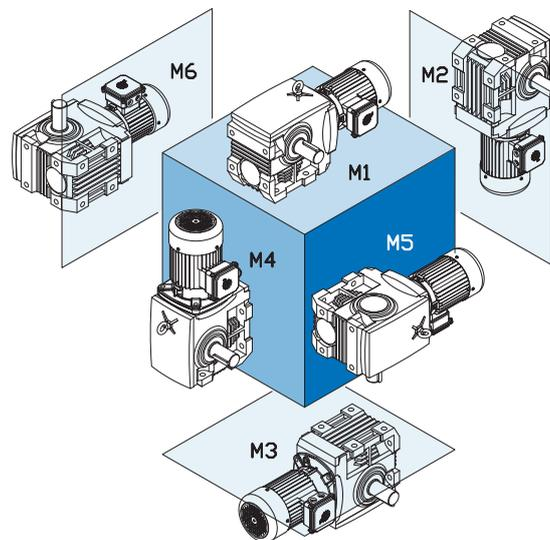

Mounting positions and cable gland – DuoDrive

Designs

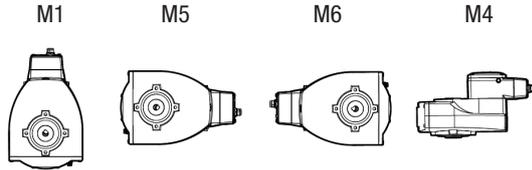

Cable gland

Device type	Cable gland
SK EVO 80	1 x M25 x 1.5 2 x M16 x 1.5
SK EVO 200	1 x M25 x 1.5 2 x M16 x 1.5

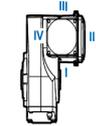
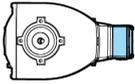
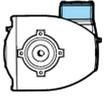
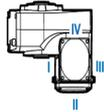
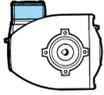
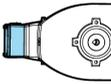
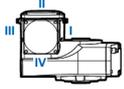
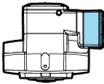
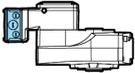
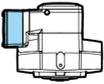
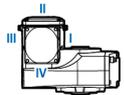
Designs	Position of electrical connection			Position of cable gland
	1	2	3	
M1				
M5				
M6				
M4				

Mounting positions – MAXXDRIVE® parallel gear units

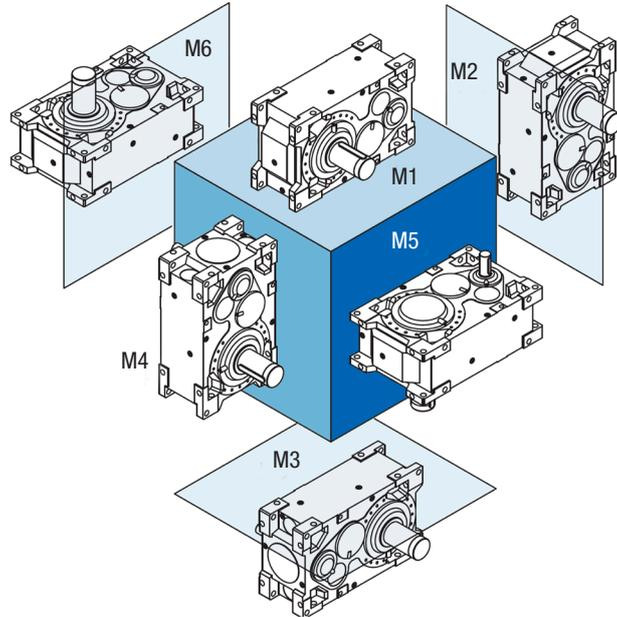

Standard mounting positions:

- SKx207: M1
- SKx307: M3
- SKx321: M1
- SKx421: M1

Mounting positions – MAXXDRIVE® right-angle gear units

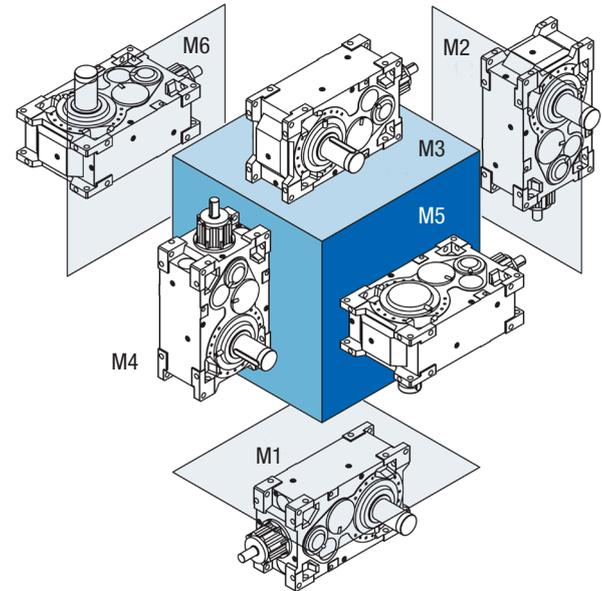

Standard mounting positions:

- SKx407: M1
- SKx507: M3
- SKx418: M1
- SKx217: M1

Mounting and terminal box positions – Motors

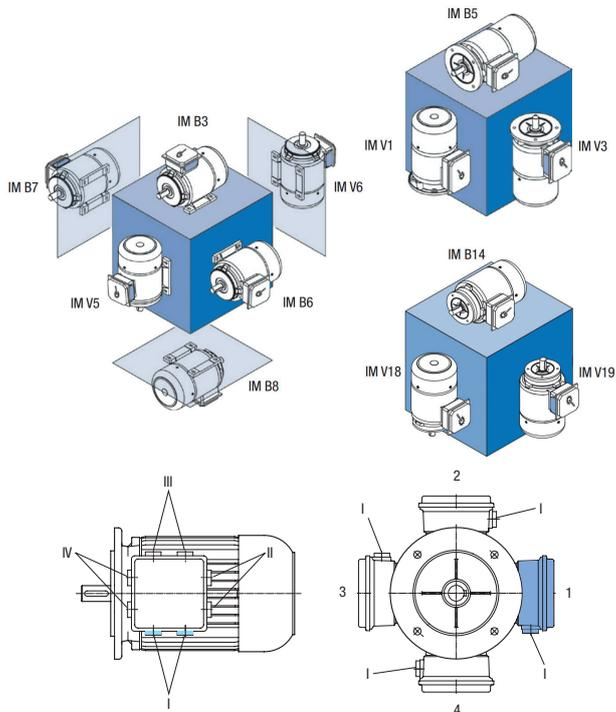

Enquiry process



Configurator for precisely tailored drives



Generate CAD data (3D models, dimension sheets, outline drawings)



Generate offer with purchase prices



Track order status

myNORD

The myNORD customer portal provides an online product configurator. The configured drive can be directly requested via the portal. A check for ATEX conformity is also possible.



myNORD

In case an online configuration is not possible, please use our enquiry forms.



NORD enquiry form

The NORD product overview is also available as a poster (part no. 6091985)

EN

Headquarters

Getriebebau NORD GmbH & Co. KG

Getriebebau-Nord-Str. 1

22941 Bargteheide, Deutschland

T: +49 45 32 / 289 0

F: +49 45 32 / 289 22 53

info@nord.com